

MDD3752

P-Channel Trench MOSFET, -40V, -43A, 17mΩ

General Description

The MDD3752 uses advanced MagnaChip's Trench MOSFET Technology to provided high performance in on-state resistance, switching performance and reliability.

Low $R_{DS(ON)}$, Low Gate Charge can be offering superior benefit in the application.

Features

- $V_{DS} = -40V$
- $I_D = -43A$ @ $V_{GS} = -10V$
- $R_{DS(ON)} < 17m\Omega$ @ $V_{GS} = -10V$
- $R_{DS(ON)} < 25m\Omega$ @ $V_{GS} = -4.5V$

Applications

- Inverters
- General purpose applications

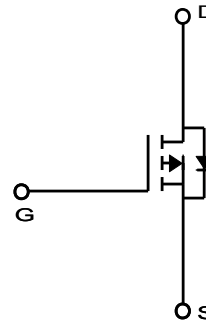
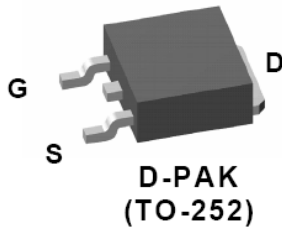

Absolute Maximum Ratings ($T_C = 25^\circ$)

Characteristics		Symbol	Rating	Unit
Drain-Source Voltage		V_{DSS}	-40	V
Gate-Source Voltage		V_{GSS}	± 20	V
Continuous Drain Current (Note 2)	$T_C = 25^\circ C$	I_D	43	A
	$T_C = 100^\circ C$		27	A
Pulsed Drain Current		I_{DM}	-90	A
Power Dissipation	$T_C = 25^\circ C$	P_D	50	W
	$T_C = 100^\circ C$		20	
Single Pulse Avalanche Energy (Note 3)		E_{AS}	128	mJ
Junction and Storage Temperature Range		T_J, T_{stg}	-55~+150	$^\circ C$

Thermal Characteristics

Characteristics		Symbol	Rating	Unit
Thermal Resistance, Junction-to-Ambient (Note 1)		$R_{\theta JA}$	40	$^\circ C/W$
Thermal Resistance, Junction-to-Case		$R_{\theta JC}$	2.5	

Ordering Information

Part Number	Temp. Range	Package	Packing	RoHS Status
MDD3752RH	-55~150°C	D-PAK	Tape & Reel	Halogen Free

Electrical Characteristics (T_J =25°C unless otherwise noted)

Characteristics	Symbol	Test Condition	Min	Typ	Max	Unit
Static Characteristics						
Drain-Source Breakdown Voltage	BV _{DSS}	I _D = -250μA, V _{GS} = 0V	-40	-	-	V
Gate Threshold Voltage	V _{GS(th)}	V _{DS} = V _{GS} , I _D = -250μA	-1.0	-2.0	-3.0	
Zero Gate Voltage Drain Current	I _{DSS}	V _{DS} = -32V, V _{GS} = 0V	-	-	-1	μA
Gate Leakage Current	I _{GSS}	V _{GS} = ±20V, V _{DS} = 0V	-	-	±0.1	
Drain-Source ON Resistance	R _{DS(ON)}	V _{GS} = -10V, I _D = -20A	-	13	17	mΩ
		V _{GS} = -4.5V, I _D = -10A	-	19	25	
Forward Transconductance	g _{FS}	V _{DS} = -10V, I _D = -20A	-	40	-	S
Dynamic Characteristics						
Total Gate Charge	Q _g	V _{DD} = -20V, I _D = -20A, V _{GS} = -10V	-	44.1	-	nC
Gate-Source Charge	Q _{gs}		-	8.6	-	
Gate-Drain Charge	Q _{gd}		-	9.3	-	
Input Capacitance	C _{iss}	V _{DS} = -20V, V _{GS} = 0V, f = 1.0MHz	-	2088	-	pF
Reverse Transfer Capacitance	C _{rss}		-	168	-	
Output Capacitance	C _{oss}		-	290	-	
Turn-On Delay Time	t _{d(on)}	V _{GS} = -10V, V _{DD} = -20V, I _D = -1A, R _{GEN} = 6.0Ω	-	17.6	-	ns
Turn-On Rise Time	t _r		-	17.8	-	
Turn-Off Delay Time	t _{d(off)}		-	59.0	-	
Turn-Off Fall Time	t _f		-	19.8	-	
Drain-Source Body Diode Characteristics						
Source-Drain Diode Forward Voltage	V _{SD}	I _S = -20A, V _{GS} = 0V	-	-	1.2	V
Reverse Recovery Time	t _{rr}	I _S = -20A, di/dt=100A/us	-	40	-	ns
Reverse Recovery Charge	Q _{rr}		-	40	-	nC

Note :

- Surface mounted RF4 board with 2oz. Copper.
- P_D is based on T_{J(MAX)}=150°C, P_D(T_C=25°C) is based on R_{θJC}.
- Starting T_J=25°C, L=1mH, I_{AS}=-16A V_{DD}=-20V, V_{GS}=-10V

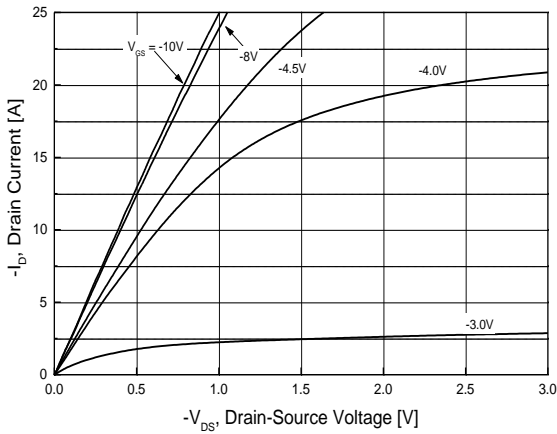

Fig.1 On-Region Characteristics

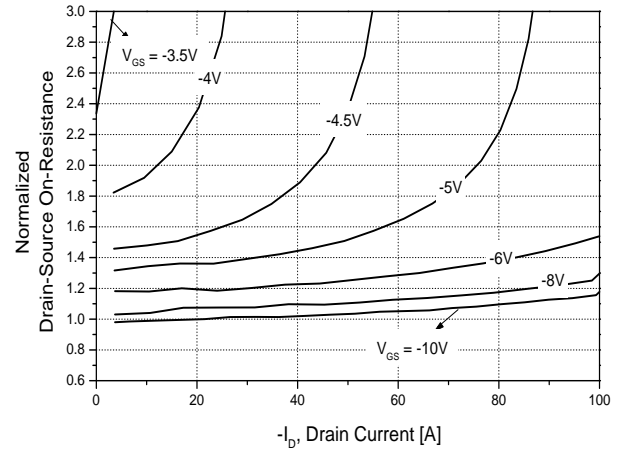

Fig.2 On-Resistance Variation with Drain Current and Gate Voltage

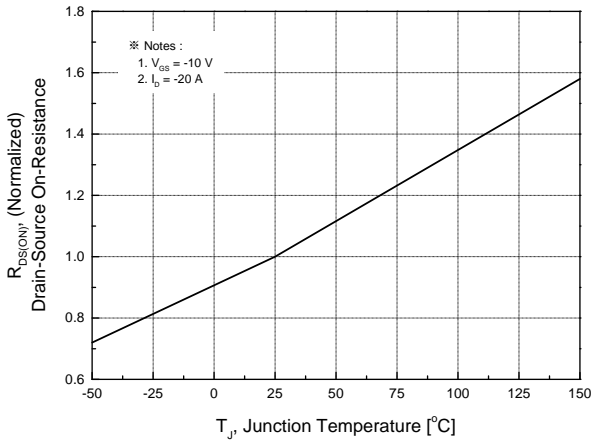

Fig.3 On-Resistance Variation with Temperature

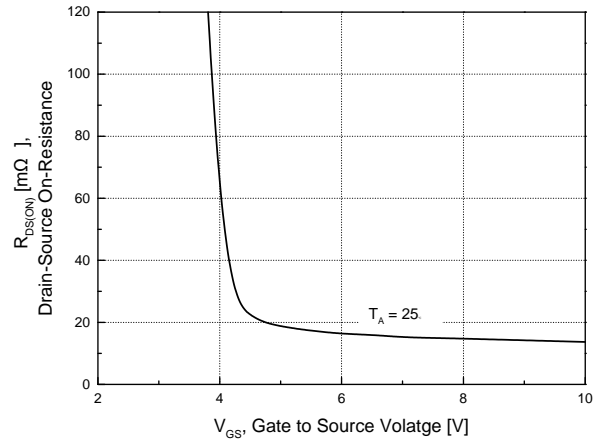

Fig.4 On-Resistance Variation with Gate to Source Voltage

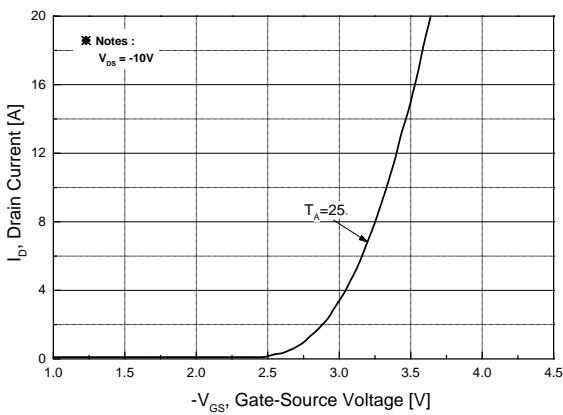

Fig.5 Transfer Characteristics

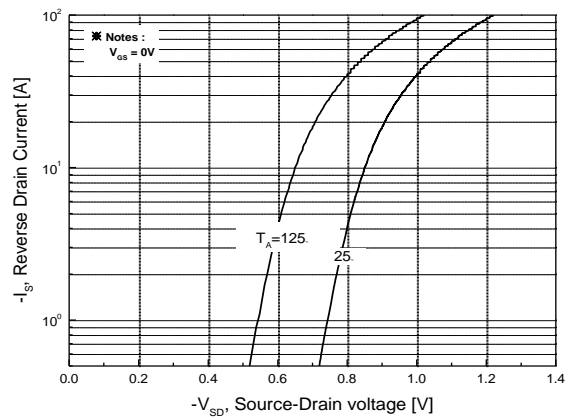

Fig.6 Body Diode Forward Voltage Variation with Source Current and Temperature

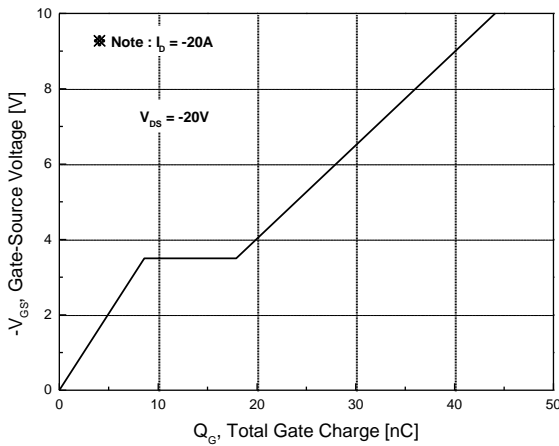

Fig.7 Gate Charge Characteristics

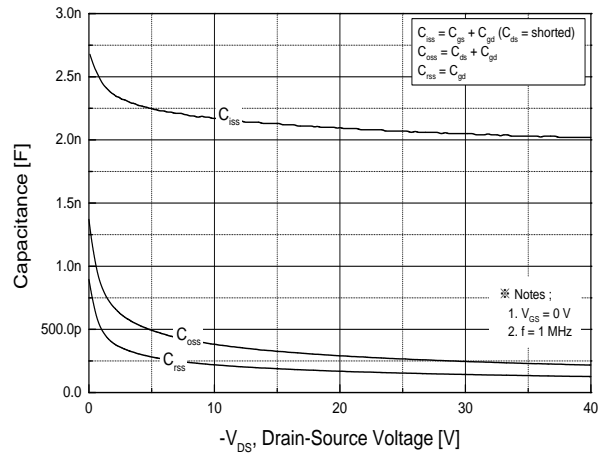

Fig.8 Capacitance Characteristics

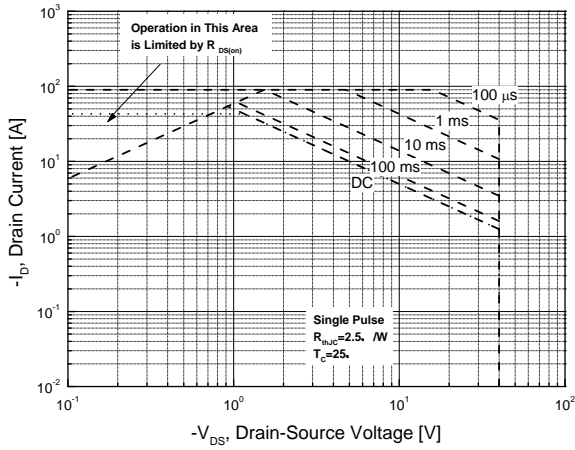

Fig.9 Maximum Safe Operating Area

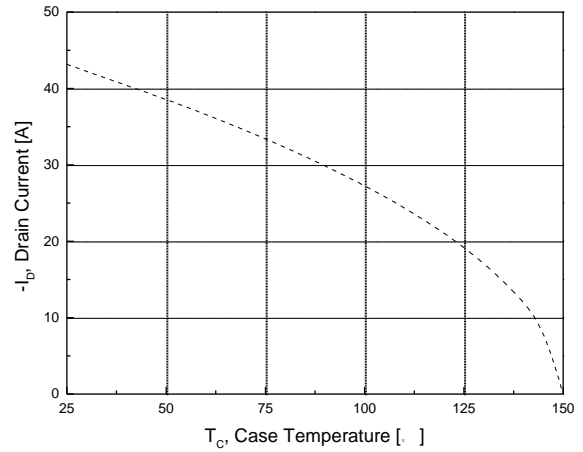

Fig.10 Maximum Drain Current vs. Case Temperature

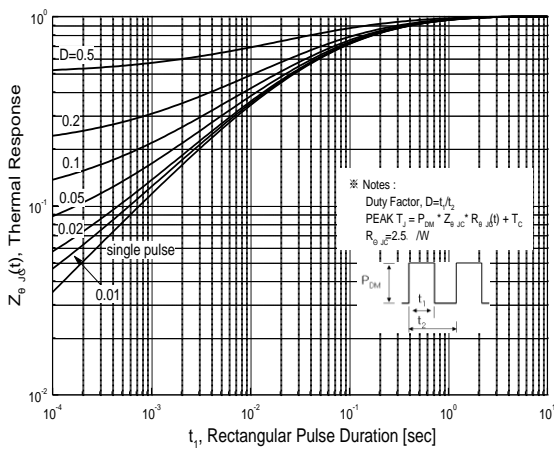
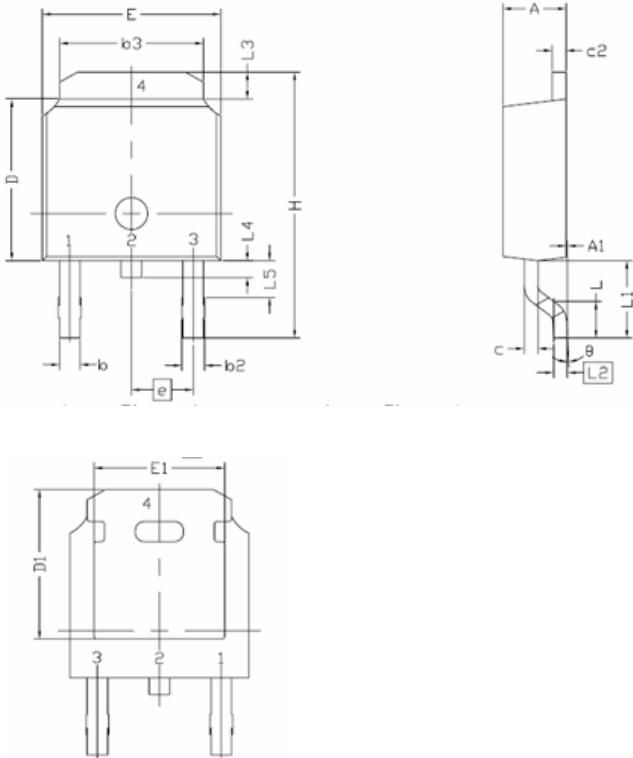

Fig.11 Transient Thermal Response Curve

Physical Dimensions

2 Leads, DPAK (TO252)

Dimensions are in millimeters unless otherwise specified



Symbol	Min.	Nom.	Max.
E	6.35	-	6.73
L	1.40	1.52	1.78
L1	2.74 REF		
L2	0.508 BCS		
L3	0.89	-	1.27
L4	-	-	1.02
L5	1.14	-	1.52
D	5.97	6.10	6.22
H	9.40	-	10.41
b	0.64	-	0.89
b2	0.76	-	1.14
b3	4.95	-	5.46
e	2.286 BSC		
A	2.18	-	2.39
A1	-	-	0.13
c	0.46	-	0.61
c2	0.46	-	0.89
D1	5.21	-	-
E1	4.32	-	-
⌀	0.00	-	10.00

DISCLAIMER:

The Products are not designed for use in hostile environments, including, without limitation, aircraft, nuclear power generation, medical appliances, and devices or systems in which malfunction of any Product can reasonably be expected to result in a personal injury. Seller's customers using or selling Seller's products for use in such applications do so at their own risk and agree to fully defend and indemnify Seller.

MagnaChip reserves the right to change the specifications and circuitry without notice at any time. MagnaChip does not consider responsibility for use of any circuitry other than circuitry entirely included in a MagnaChip product. [MagnaChip](#) is a registered trademark of MagnaChip Semiconductor Ltd.