

NTR4101P, NTRV4101P

MOSFET – Power, Single P-Channel, Trench, SOT-23 –20 V

Features

- Leading –20 V Trench for Low $R_{DS(on)}$
- –1.8 V Rated for Low Voltage Gate Drive
- SOT-23 Surface Mount for Small Footprint
- NTRV Prefix for Automotive and Other Applications Requiring Unique Site and Control Change Requirements; AEC-Q101 Qualified and PPAP Capable
- These Devices are Pb-Free, Halogen Free/BFR Free and are RoHS Compliant

Applications

- Load/Power Management for Portables
- Load/Power Management for Computing
- Charging Circuits and Battery Protection

MAXIMUM RATINGS ($T_J = 25^\circ\text{C}$ unless otherwise noted)

Parameter		Symbol	Value	Unit	
Drain-to-Source Voltage		V_{DS}	–20	V	
Gate-to-Source Voltage		V_{GS}	± 8.0	V	
Continuous Drain Current (Note 1)	Steady State	$T_A = 25^\circ\text{C}$	I_D	–2.4	A
		$T_A = 85^\circ\text{C}$		–1.7	
	$t \leq 10$ s	$T_A = 25^\circ\text{C}$		–3.2	
Power Dissipation (Note 1)	Steady State	$T_A = 25^\circ\text{C}$	P_D	0.73	W
				1.25	
Continuous Drain Current (Note 2)	Steady State	$T_A = 25^\circ\text{C}$	I_D	–1.8	A
		$T_A = 85^\circ\text{C}$		–1.3	
		$T_A = 25^\circ\text{C}$	P_D	0.42	W
Pulsed Drain Current	$t_p = 10$ μs	I_{DM}	–18	A	
ESD Capability (Note 3)	$C = 100$ pF, $R_S = 1500$ Ω	ESD	225	V	
Operating Junction and Storage Temperature		T_J, T_{STG}	–55 to 150	$^\circ\text{C}$	
Source Current (Body Diode)		I_S	–2.4	A	
Single Pulse Drain-to-Source Avalanche Energy ($V_{GS} = -8$ V, $I_L = -1.8$ Apk, $L = 10$ mH, $R_G = 25$ Ω)		EAS	16	mJ	
Lead Temperature for Soldering Purposes (1/8" from case for 10 s)		T_L	260	$^\circ\text{C}$	

Stresses exceeding those listed in the Maximum Ratings table may damage the device. If any of these limits are exceeded, device functionality should not be assumed, damage may occur and reliability may be affected.



ON Semiconductor®

www.onsemi.com

$V_{(BR)DSS}$	$R_{DS(ON)}$ TYP	I_D MAX
–20 V	70 m Ω @ –4.5 V	–3.2 A
	90 m Ω @ –2.5 V	
	112 m Ω @ –1.8 V	

P-Channel MOSFET

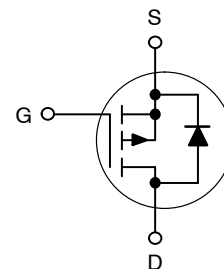

MARKING DIAGRAM & PIN ASSIGNMENT

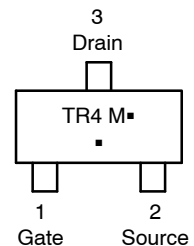
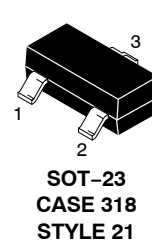

TR4 = Device Code
M = Date Code
▪ = Pb-Free Package

(Note: Microdot may be in either location)

ORDERING INFORMATION

Device	Package	Shipping†
NTR4101PT1G	SOT-23 (Pb-Free)	3000 / Tape & Reel
NTRV4101PT1G		

†For information on tape and reel specifications, including part orientation and tape sizes, please refer to our Tape and Reel Packaging Specifications Brochure, BRD8011/D.

NTR4101P, NTRV4101P

THERMAL RESISTANCE RATINGS

Parameter	Symbol	Max	Unit
Junction-to-Ambient – Steady State (Note 1)	$R_{\theta JA}$	170	°C/W
Junction-to-Ambient – $t < 10$ s (Note 1)	$R_{\theta JA}$	100	
Junction-to-Ambient – Steady State (Note 2)	$R_{\theta JA}$	300	

- Surface-mounted on FR4 board using 1 in sq pad size (Cu area = 1.127 in sq [1 oz] including traces)
- Surface-mounted on FR4 board using the minimum recommended pad size.
- ESD Rating Information: HBM Class 0

ELECTRICAL CHARACTERISTICS ($T_A = 25^\circ\text{C}$ unless otherwise noted)

Characteristic	Symbol	Min	Typ	Max	Unit
----------------	--------	-----	-----	-----	------

OFF CHARACTERISTICS

Drain-to-Source Breakdown Voltage (Note 4) ($V_{GS} = 0$ V, $I_D = -250$ μA)	$V_{(BR)DSS}$	-20			V
Zero Gate Voltage Drain Current (Note 4) ($V_{GS} = 0$ V, $V_{DS} = -16$ V)	I_{DSS}			-1.0	μA
Gate-to-Source Leakage Current ($V_{GS} = \pm 8.0$ V, $V_{DS} = 0$ V)	I_{GSS}			± 100	nA

ON CHARACTERISTICS

Gate Threshold Voltage (Note 4) ($V_{GS} = V_{DS}$, $I_D = -250$ μA)	$V_{GS(th)}$	-0.4	-0.72	-1.2	V
Drain-to-Source On-Resistance ($V_{GS} = -4.5$ V, $I_D = -1.6$ A) ($V_{GS} = -2.5$ V, $I_D = -1.3$ A) ($V_{GS} = -1.8$ V, $I_D = -0.9$ A)	$R_{DS(on)}$		70 90 112	85 120 210	m Ω
Forward Transconductance ($V_{DS} = -5.0$ V, $I_D = -2.3$ A)	g_{FS}		7.5		S

CHARGES, CAPACITANCES & GATE RESISTANCE

Input Capacitance	$(V_{GS} = 0$ V, $f = 1$ MHz, $V_{DS} = -10$ V)	C_{iss}	675		pF
Output Capacitance		C_{oss}	100		
Reverse Transfer Capacitance		C_{rss}	75		
Total Gate Charge	$(V_{GS} = -4.5$ V, $V_{DS} = -10$ V, $I_D = -1.6$ A)	$Q_{G(tot)}$	7.5	8.5	nC
Gate-to-Source Gate Charge	$(V_{DS} = -10$ V, $I_D = -1.6$ A)	Q_{GS}	1.2		nC
Gate-to-Drain "Miller" Charge	$(V_{DS} = -10$ V, $I_D = -1.6$ A)	Q_{GD}	2.2		nC
Gate Resistance		R_G	6.5		Ω

SWITCHING CHARACTERISTICS (Note 5)

Turn-On Delay Time	$(V_{GS} = -4.5$ V, $V_{DS} = -10$ V, $I_D = -1.6$ A, $R_G = 6.0$ Ω)	$t_{d(on)}$	7.5		ns
Rise Time		t_r	12.6		
Turn-Off Delay Time		$t_{d(off)}$	30.2		
Fall Time		t_f	21.0		

DRAIN-SOURCE DIODE CHARACTERISTICS

Forward Diode Voltage	$(V_{GS} = 0$ V, $I_S = -2.4$ A)	V_{SD}		-0.82	-1.2	V
Reverse Recovery Time	$(V_{GS} = 0$ V, $dI_{SD}/dt = 100$ A/ μs , $I_S = -1.6$ A)	t_{rr}		12.8	15	ns
Charge Time		t_a		9.9		ns
Discharge Time		t_b		3.0		ns
Reverse Recovery Charge		Q_{rr}		1008		nC

Product parametric performance is indicated in the Electrical Characteristics for the listed test conditions, unless otherwise noted. Product performance may not be indicated by the Electrical Characteristics if operated under different conditions.

- Pulse Test: Pulse Width ≤ 300 μs , Duty Cycle $\leq 2\%$.
- Switching characteristics are independent of operating junction temperature.

NTR4101P, NTRV4101P

TYPICAL PERFORMANCE CURVES ($T_J = 25^\circ\text{C}$ unless otherwise noted)

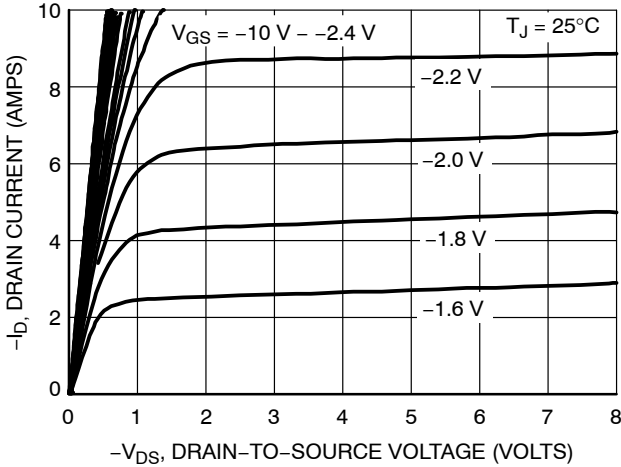

Figure 1. On-Region Characteristics

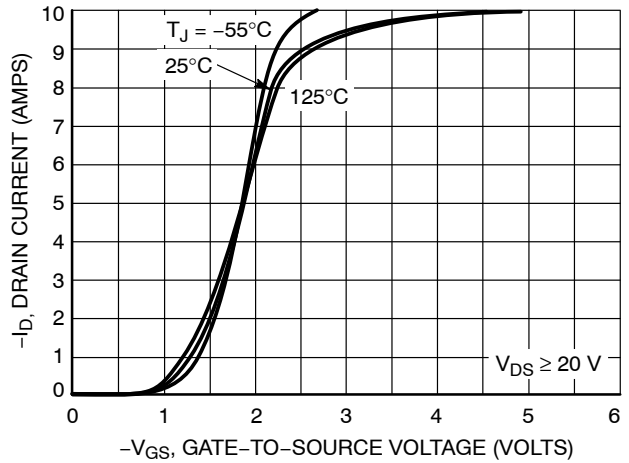

Figure 2. Transfer Characteristics

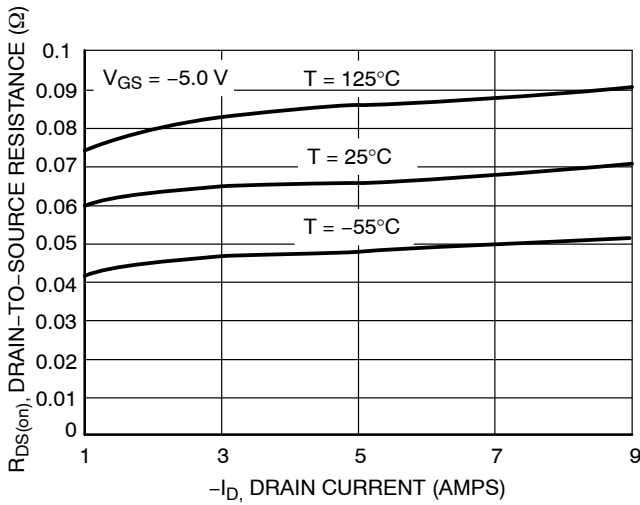

Figure 3. On-Resistance vs. Drain Current and Temperature

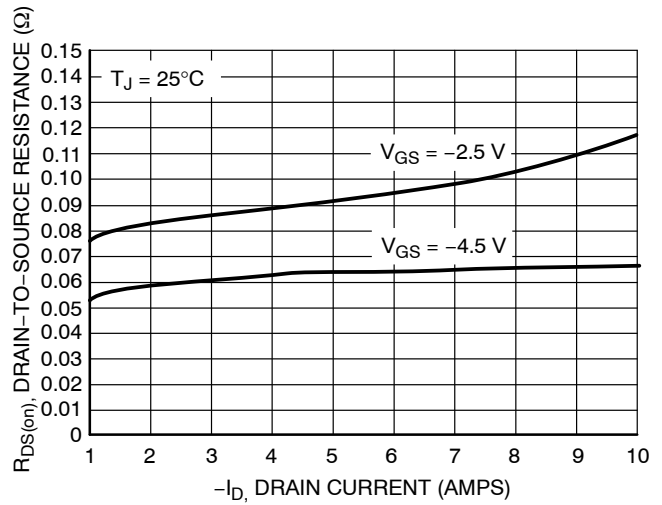

Figure 4. On-Resistance vs. Drain Current and Temperature

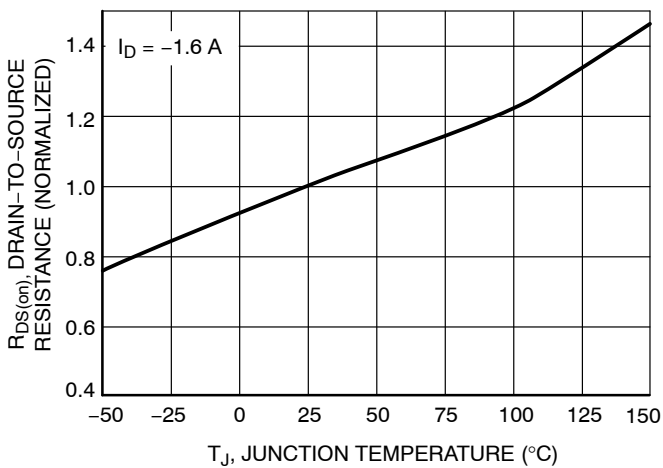

Figure 5. On-Resistance Variation with Temperature

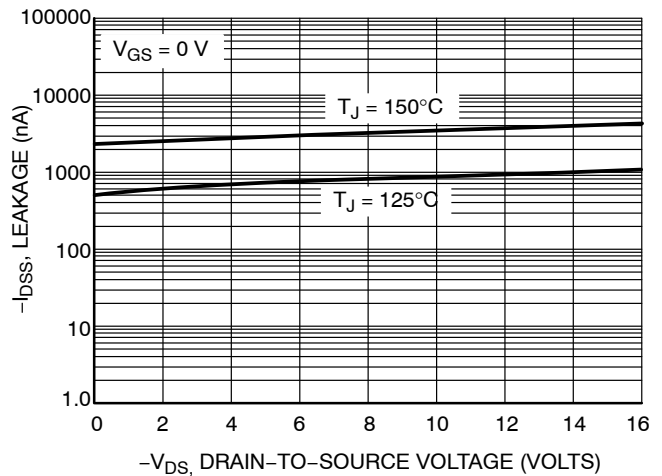

Figure 6. Drain-to-Source Leakage Current vs. Voltage

NTR4101P, NTRV4101P

TYPICAL PERFORMANCE CURVES ($T_J = 25^\circ\text{C}$ unless otherwise noted)

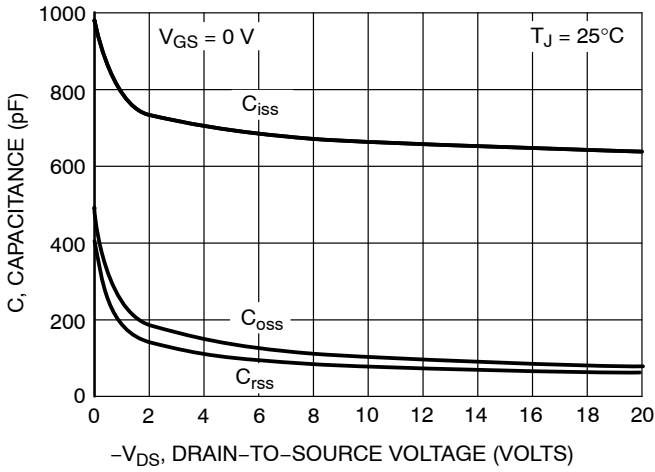

Figure 7. Capacitance Variation

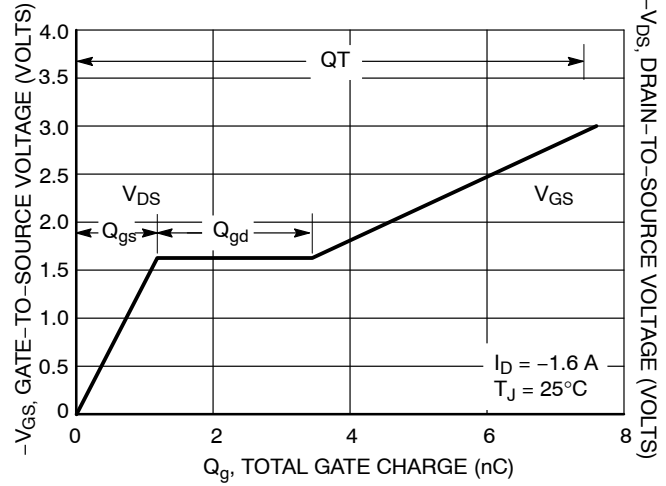

Figure 8. Gate-to-Source and Drain-to-Source Voltage vs. Total Gate Charge

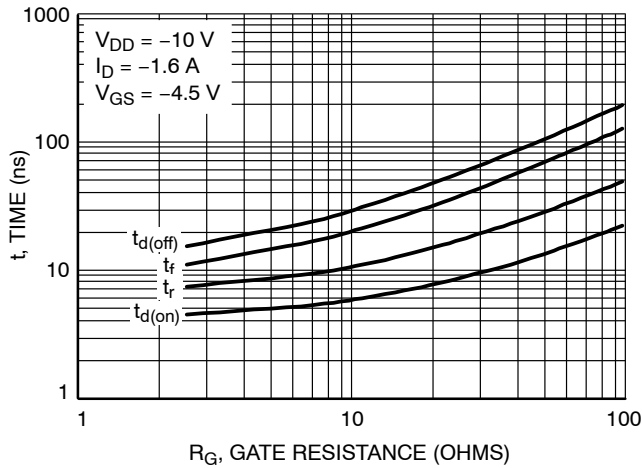

Figure 9. Resistive Switching Time Variation vs. Gate Resistance

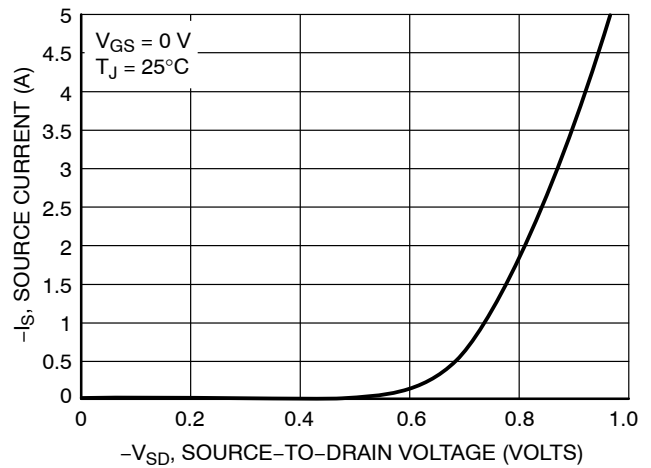

Figure 10. Diode Forward Voltage vs. Current

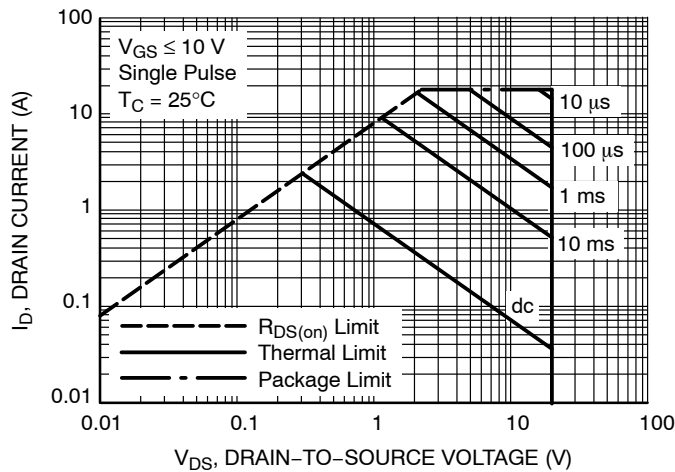
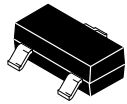

Figure 11. Maximum Rated Forward Biased Safe Operating Area

MECHANICAL CASE OUTLINE

PACKAGE DIMENSIONS

ON Semiconductor®



SOT-23 (TO-236)
CASE 318-08
ISSUE AS

DATE 30 JAN 2018

SCALE 4:1

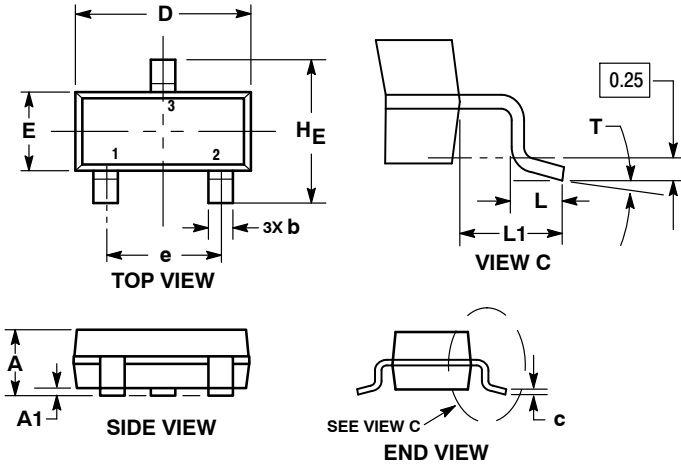

NOTES:

1. DIMENSIONING AND TOLERANCING PER ASME Y14.5M, 1994.
2. CONTROLLING DIMENSION: MILLIMETERS.
3. MAXIMUM LEAD THICKNESS INCLUDES LEAD FINISH. MINIMUM LEAD THICKNESS IS THE MINIMUM THICKNESS OF THE BASE MATERIAL.
4. DIMENSIONS D AND E DO NOT INCLUDE MOLD FLASH, PROTRUSIONS, OR GATE BURRS.

DIM	MILLIMETERS			INCHES		
	MIN	NOM	MAX	MIN	NOM	MAX
A	0.89	1.00	1.11	0.035	0.039	0.044
A1	0.01	0.06	0.10	0.000	0.002	0.004
b	0.37	0.44	0.50	0.015	0.017	0.020
c	0.08	0.14	0.20	0.003	0.006	0.008
D	2.80	2.90	3.04	0.110	0.114	0.120
E	1.20	1.30	1.40	0.047	0.051	0.055
e	1.78	1.90	2.04	0.070	0.075	0.080
L	0.30	0.43	0.55	0.012	0.017	0.022
L1	0.35	0.54	0.69	0.014	0.021	0.027
HE	2.10	2.40	2.64	0.083	0.094	0.104
T	0°	---	10°	0°	---	10°

RECOMMENDED SOLDERING FOOTPRINT

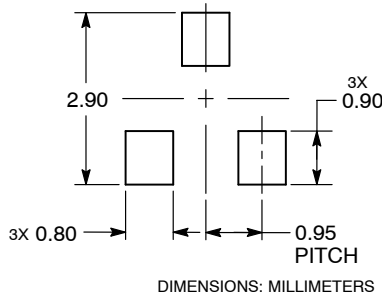

GENERIC MARKING DIAGRAM*

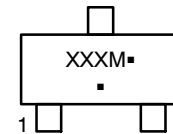

XXX = Specific Device Code
M = Date Code
▪ = Pb-Free Package

*This information is generic. Please refer to device data sheet for actual part marking. Pb-Free indicator, "G" or microdot "▪", may or may not be present.

STYLE 1 THRU 5:
CANCELLED

STYLE 6:
PIN 1. BASE
2. EMITTER
3. COLLECTOR

STYLE 7:
PIN 1. EMITTER
2. BASE
3. COLLECTOR

STYLE 8:
PIN 1. ANODE
2. NO CONNECTION
3. CATHODE

STYLE 9:
PIN 1. ANODE
2. ANODE
3. CATHODE

STYLE 10:
PIN 1. DRAIN
2. SOURCE
3. GATE

STYLE 11:
PIN 1. ANODE
2. CATHODE
3. CATHODE-ANODE

STYLE 12:
PIN 1. CATHODE
2. CATHODE
3. ANODE

STYLE 13:
PIN 1. SOURCE
2. DRAIN
3. GATE

STYLE 14:
PIN 1. CATHODE
2. GATE
3. ANODE

STYLE 15:
PIN 1. GATE
2. CATHODE
3. ANODE

STYLE 16:
PIN 1. ANODE
2. CATHODE
3. CATHODE

STYLE 17:
PIN 1. NO CONNECTION
2. ANODE
3. CATHODE

STYLE 18:
PIN 1. NO CONNECTION
2. CATHODE
3. ANODE

STYLE 19:
PIN 1. CATHODE
2. ANODE
3. CATHODE-ANODE

STYLE 20:
PIN 1. CATHODE
2. ANODE
3. GATE

STYLE 21:
PIN 1. GATE
2. SOURCE
3. DRAIN

STYLE 22:
PIN 1. RETURN
2. OUTPUT
3. INPUT

STYLE 23:
PIN 1. ANODE
2. ANODE
3. CATHODE

STYLE 24:
PIN 1. GATE
2. DRAIN
3. SOURCE

STYLE 25:
PIN 1. ANODE
2. CATHODE
3. GATE

STYLE 26:
PIN 1. CATHODE
2. ANODE
3. NO CONNECTION

STYLE 27:
PIN 1. CATHODE
2. CATHODE
3. CATHODE

STYLE 28:
PIN 1. ANODE
2. ANODE
3. ANODE

DOCUMENT NUMBER:	98ASB42226B	Electronic versions are uncontrolled except when accessed directly from the Document Repository. Printed versions are uncontrolled except when stamped "CONTROLLED COPY" in red.
DESCRIPTION:	SOT-23 (TO-236)	PAGE 1 OF 1

ON Semiconductor and ON are trademarks of Semiconductor Components Industries, LLC dba ON Semiconductor or its subsidiaries in the United States and/or other countries. ON Semiconductor reserves the right to make changes without further notice to any products herein. ON Semiconductor makes no warranty, representation or guarantee regarding the suitability of its products for any particular purpose, nor does ON Semiconductor assume any liability arising out of the application or use of any product or circuit, and specifically disclaims any and all liability, including without limitation special, consequential or incidental damages. ON Semiconductor does not convey any license under its patent rights nor the rights of others.

ON Semiconductor and  are trademarks of Semiconductor Components Industries, LLC dba ON Semiconductor or its subsidiaries in the United States and/or other countries. ON Semiconductor owns the rights to a number of patents, trademarks, copyrights, trade secrets, and other intellectual property. A listing of ON Semiconductor's product/patent coverage may be accessed at www.onsemi.com/site/pdf/Patent-Marking.pdf. ON Semiconductor reserves the right to make changes without further notice to any products herein. ON Semiconductor makes no warranty, representation or guarantee regarding the suitability of its products for any particular purpose, nor does ON Semiconductor assume any liability arising out of the application or use of any product or circuit, and specifically disclaims any and all liability, including without limitation special, consequential or incidental damages. Buyer is responsible for its products and applications using ON Semiconductor products, including compliance with all laws, regulations and safety requirements or standards, regardless of any support or applications information provided by ON Semiconductor. "Typical" parameters which may be provided in ON Semiconductor data sheets and/or specifications can and do vary in different applications and actual performance may vary over time. All operating parameters, including "Typicals" must be validated for each customer application by customer's technical experts. ON Semiconductor does not convey any license under its patent rights nor the rights of others. ON Semiconductor products are not designed, intended, or authorized for use as a critical component in life support systems or any FDA Class 3 medical devices or medical devices with a same or similar classification in a foreign jurisdiction or any devices intended for implantation in the human body. Should Buyer purchase or use ON Semiconductor products for any such unintended or unauthorized application, Buyer shall indemnify and hold ON Semiconductor and its officers, employees, subsidiaries, affiliates, and distributors harmless against all claims, costs, damages, and expenses, and reasonable attorney fees arising out of, directly or indirectly, any claim of personal injury or death associated with such unintended or unauthorized use, even if such claim alleges that ON Semiconductor was negligent regarding the design or manufacture of the part. ON Semiconductor is an Equal Opportunity/Affirmative Action Employer. This literature is subject to all applicable copyright laws and is not for resale in any manner.

PUBLICATION ORDERING INFORMATION

LITERATURE FULFILLMENT:

Email Requests to: orderlit@onsemi.com

ON Semiconductor Website: www.onsemi.com

TECHNICAL SUPPORT

North American Technical Support:
Voice Mail: 1 800-282-9855 Toll Free USA/Canada
Phone: 011 421 33 790 2910

Europe, Middle East and Africa Technical Support:

Phone: 00421 33 790 2910

For additional information, please contact your local Sales Representative

Mouser Electronics

Authorized Distributor

Click to View Pricing, Inventory, Delivery & Lifecycle Information:

[ON Semiconductor:](#)

[NTR4101PT1H](#)