

RJH30H1DPP-M0

Silicon N Channel IGBT
High speed power switching

R07DS0463EJ0200
Rev.2.00
Jun 15, 2011

Features

- Trench gate and thin wafer technology (G6H-II series)
- High speed switching: $t_r = 80$ ns typ., $t_f = 150$ ns typ.
- Low collector to emitter saturation voltage: $V_{CE(sat)} = 1.5$ V typ.
- Low leak current: $I_{CES} = 1$ μ A max.
- Built-in Fast Recovery Diode: $V_F = 1.4$ V typ., $t_{rr} = 23$ ns typ.
- Isolated package: TO-220FL

Outline

RENESAS Package code: PRSS0003AF-A
(Package name: TO-220FL)

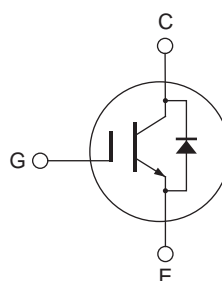
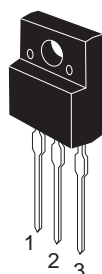

1. Gate
2. Collector
3. Emitter

Absolute Maximum Ratings

($T_c = 25^\circ\text{C}$)

Item	Symbol	Ratings	Unit
Collector to emitter voltage	V_{CES}	360	V
Gate to emitter voltage	V_{GES}	± 30	V
Collector current	I_C	30	A
Collector peak current	$i_{c(peak)}$ ^{Note1}	200	A
Collector to emitter diode Forward peak current	$i_{DF(peak)}$ ^{Note1}	100	A
Collector dissipation	P_C ^{Note2}	20	W
Junction to case thermal impedance	θ_{j-c}	6.25	$^\circ\text{C}/\text{W}$
Junction temperature	T_j	150	$^\circ\text{C}$
Storage temperature	T_{stg}	-55 to +150	$^\circ\text{C}$

- Notes: 1. $PW \leq 10$ μ s, duty cycle $\leq 1\%$
2. $T_c = 25^\circ\text{C}$

Electrical Characteristics

(T_j = 25°C)

Item	Symbol	Min	Typ	Max	Unit	Test Conditions
Zero gate voltage collector current	I _{CEs}	—	—	1	μA	V _{CE} = 360 V, V _{GE} = 0
Gate to emitter leak current	I _{GES}	—	—	±100	nA	V _{GE} = ± 30 V, V _{CE} = 0
Gate to emitter cutoff voltage	V _{GE(off)}	2.5	—	5	V	V _{CE} = 10 V, I _C = 1 mA
Collector to emitter saturation voltage	V _{CE(sat)}	—	1.5	2	V	I _C = 30A, V _{GE} = 15 V ^{Note3}
Input capacitance	C _{ies}	—	740	—	pF	V _{CE} = 25 V V _{GE} = 0 f = 1 MHz
Output capacitance	C _{oes}	—	60	—	pF	
Reveres transfer capacitance	C _{res}	—	17	—	pF	
Total gate charge	Q _g	—	23	—	nC	V _{GE} = 15 V V _{CE} = 150 V I _C = 30 A
Gate to emitter charge	Q _{ge}	—	4	—	nC	
Gate to collector charge	Q _{gc}	—	8	—	nC	
Switching time	t _{d(on)}	—	0.02	—	μs	I _C = 30 A R _L = 5 Ω V _{GE} = 15 V R _G = 5 Ω
	t _r	—	0.08	—	μs	
	t _{d(off)}	—	0.04	—	μs	
	t _f	—	0.15	—	μs	
FRD Forward voltage	V _F	—	1.4	1.7	V	I _F = 20 A ^{Note3}
FRD Reverse recovery time	t _{rr}	—	23	—	ns	I _F = 20 A di _F /dt = 100 A/μs

Notes: 3. Pulse test

Main Characteristics

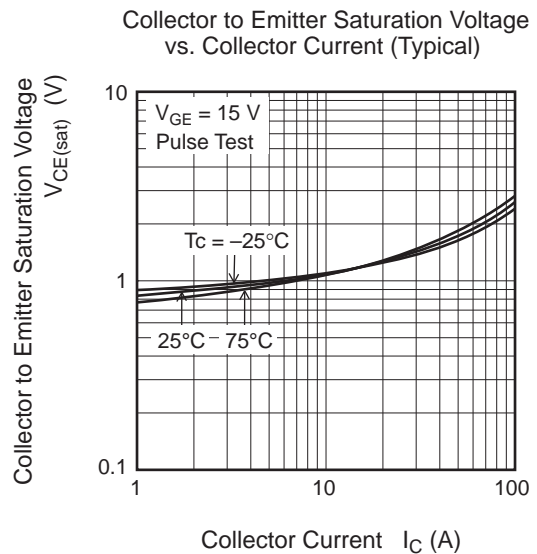
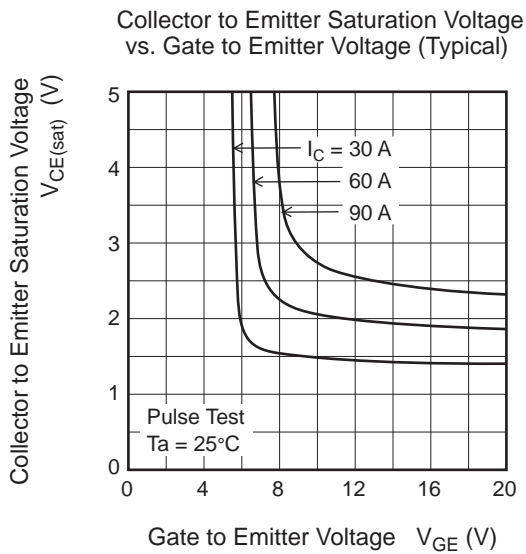
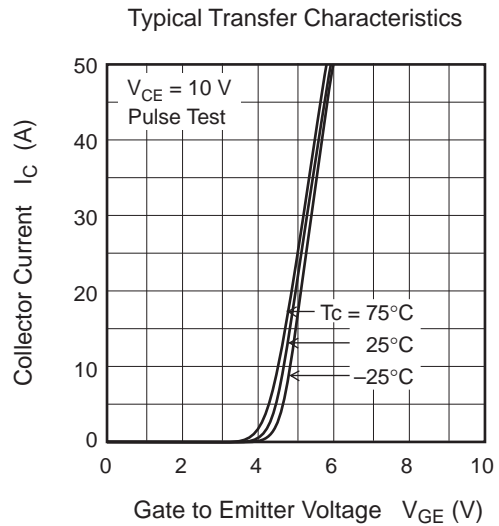
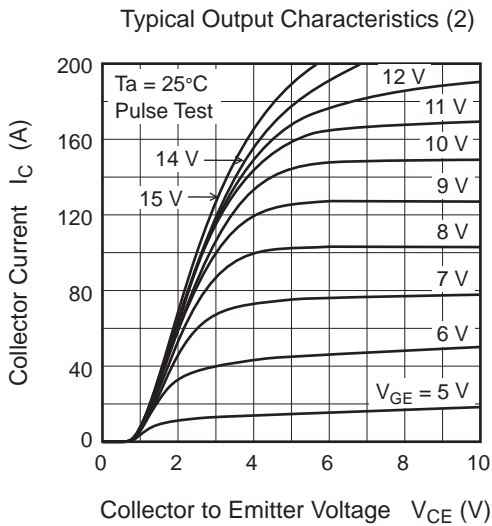
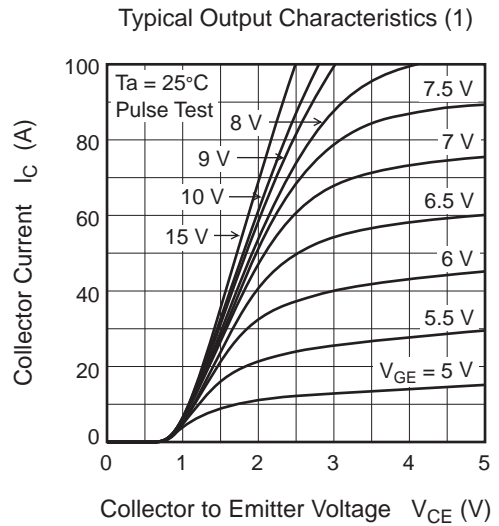
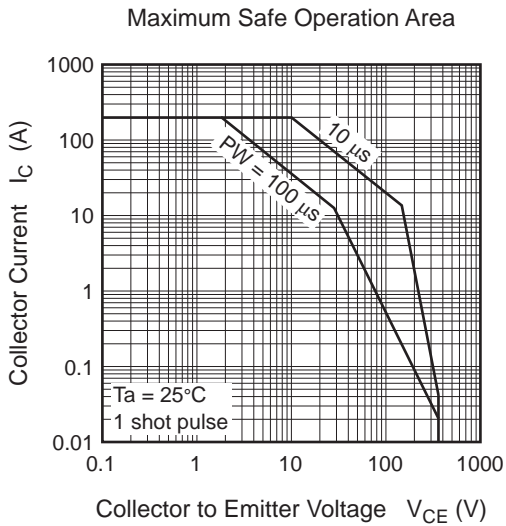

Typical Capacitance vs. Collector to Emitter Voltage

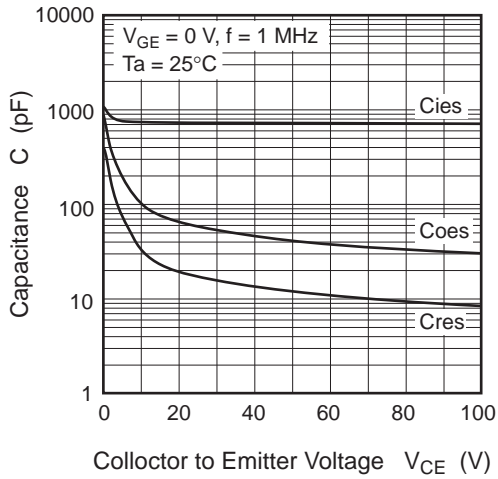

Dynamic Input Characteristics (Typical)

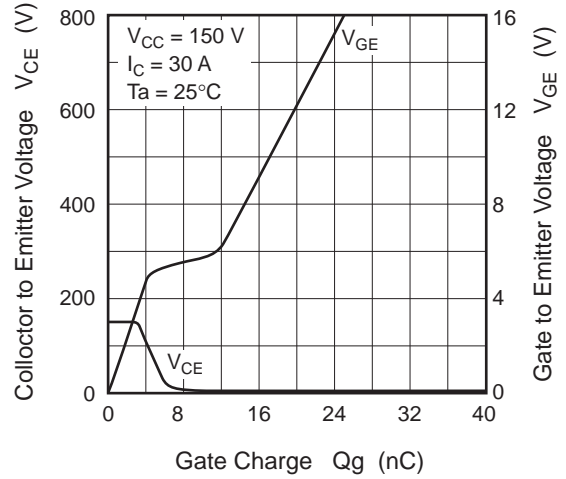

Switching Characteristics (Typical) (1)

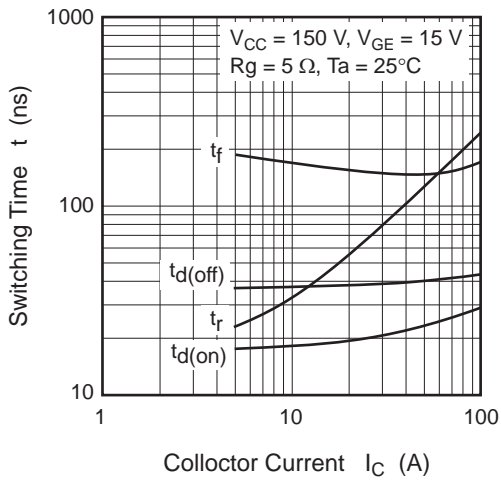

Switching Characteristics (Typical) (2)

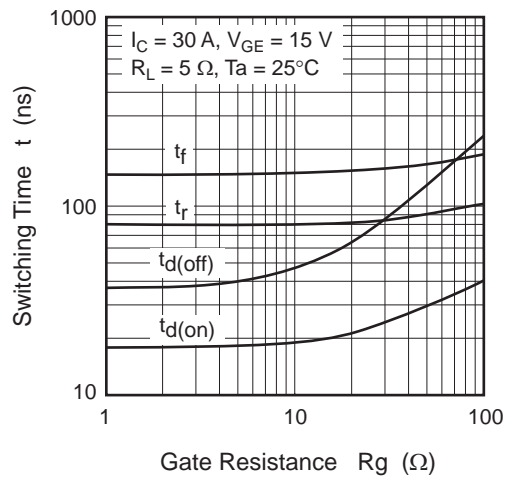

Switching Characteristics (Typical) (3)

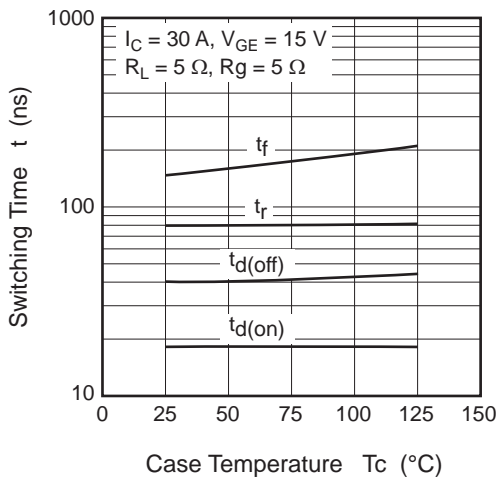

Collector to Emitter Diode Forward Voltage vs. Diode Forward Current

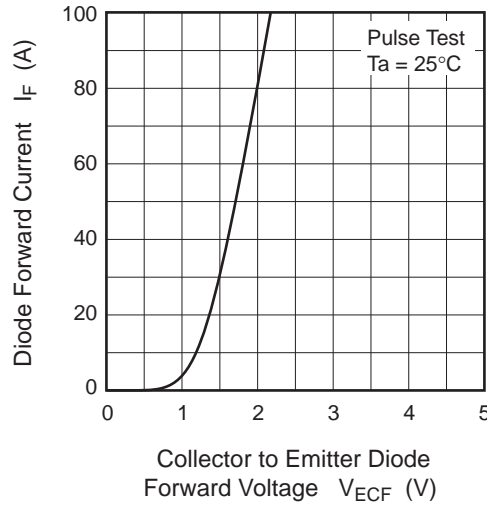

Normalized Transient Thermal Impedance vs. Pulse Width

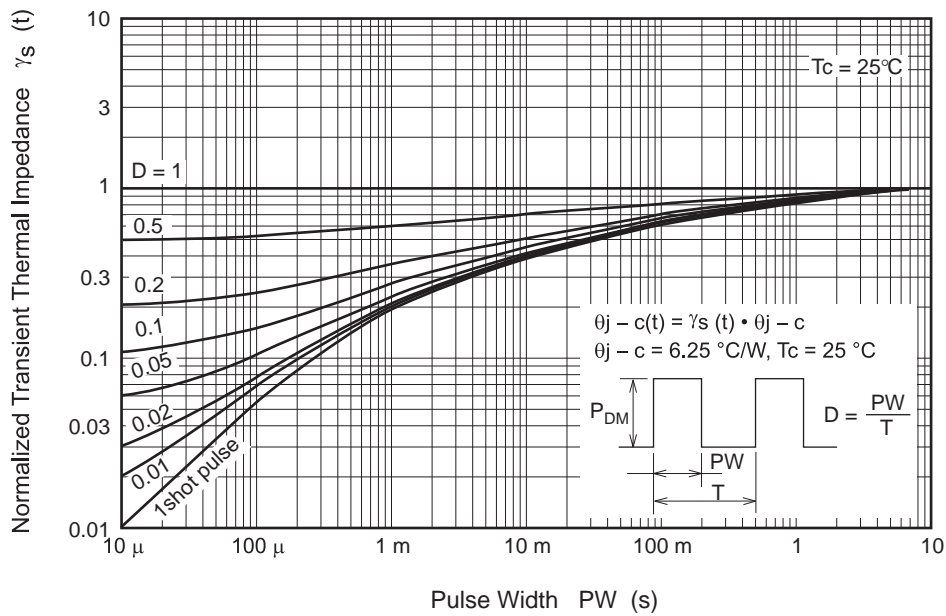

Switching Time Test Circuit

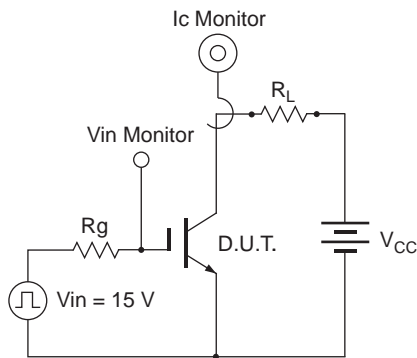

Waveform

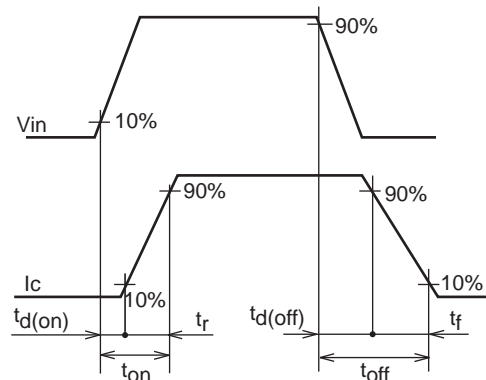

Package Dimensions

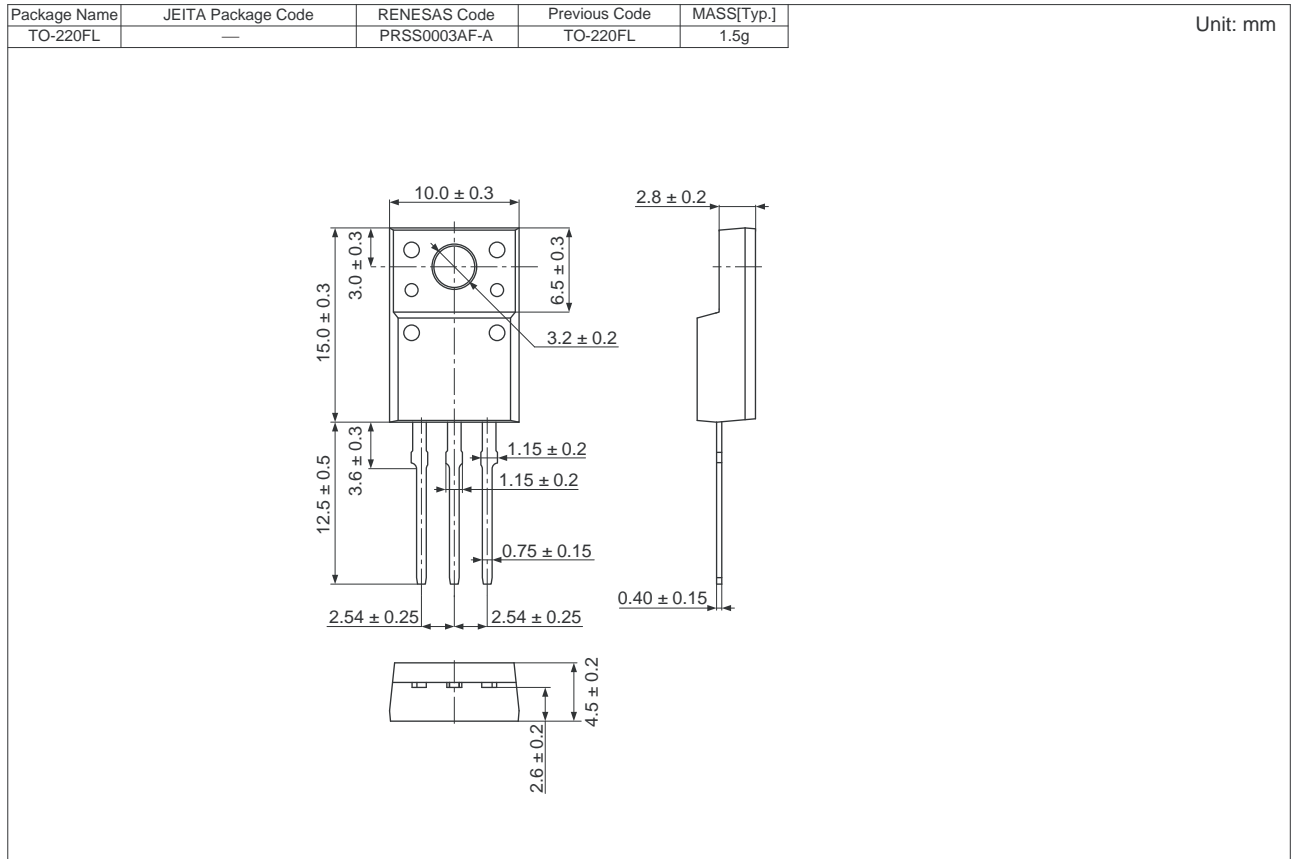

Ordering Information

Orderable Part Number	Quantity	Shipping Container
RJH30H1DPP-M0-T2	600 pcs	Box (Tube)