

MJE350G

Plastic Medium-Power PNP Silicon Transistor

This device is designed for use in line-operated applications such as low power, line-operated series pass and switching regulators requiring PNP capability.

Features

- High Collector–Emitter Sustaining Voltage
- Excellent DC Current Gain
- Complement to MJE340
- These Devices are Pb–Free and are RoHS Compliant*

MAXIMUM RATINGS

| Rating | Symbol | Value | Unit |
|--|----------------|-------------|---------------------------|
| Collector–Emitter Voltage | V_{CE0} | 300 | Vdc |
| Emitter–Base Voltage | V_{EB} | 3.0 | Vdc |
| Collector Current – Continuous | I_C | 500 | mAdc |
| Total Power Dissipation @ $T_C = 25^\circ\text{C}$ Derate above 25°C | P_D | 20 0.16 | W mW/ $^\circ\text{C}$ |
| Operating and Storage Junction Temperature Range | T_J, T_{stg} | –65 to +150 | $^\circ\text{C}$ |

Stresses exceeding those listed in the Maximum Ratings table may damage the device. If any of these limits are exceeded, device functionality should not be assumed, damage may occur and reliability may be affected.

THERMAL CHARACTERISTICS

| Characteristic | Symbol | Max | Unit |
|--------------------------------------|-----------------|------|---------------------------|
| Thermal Resistance, Junction–to–Case | $R_{\theta JC}$ | 6.25 | $^\circ\text{C}/\text{W}$ |

ELECTRICAL CHARACTERISTICS ($T_C = 25^\circ\text{C}$ unless otherwise noted)

| Characteristic | Symbol | Min | Max | Unit |
|----------------|--------|-----|-----|------|
|----------------|--------|-----|-----|------|

OFF CHARACTERISTICS

| | | | | |
|---|----------------|-----|-----|-----------------|
| Collector–Emitter Sustaining Voltage ($I_C = 1.0 \text{ mAdc}, I_B = 0$) | $V_{CE0(sus)}$ | 300 | – | Vdc |
| Collector Cutoff Current ($V_{CB} = 300 \text{ Vdc}, I_E = 0$) | I_{CBO} | – | 100 | μAdc |
| Emitter Cutoff Current ($V_{EB} = 3.0 \text{ Vdc}, I_C = 0$) | I_{EBO} | – | 100 | μAdc |

ON CHARACTERISTICS

| | | | | |
|---|----------|----|-----|---|
| DC Current Gain ($I_C = 50 \text{ mAdc}, V_{CE} = 10 \text{ Vdc}$) | h_{FE} | 30 | 240 | – |
|---|----------|----|-----|---|

Product parametric performance is indicated in the Electrical Characteristics for the listed test conditions, unless otherwise noted. Product performance may not be indicated by the Electrical Characteristics if operated under different conditions.

*For additional information on our Pb–Free strategy and soldering details, please download the ON Semiconductor Soldering and Mounting Techniques Reference Manual, SOLDERRM/D.



ON Semiconductor®

www.onsemi.com

**0.5 AMPERE
POWER TRANSISTOR
PNP SILICON
300 VOLTS, 20 WATTS**

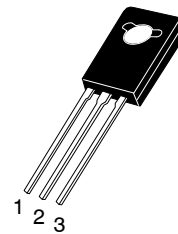
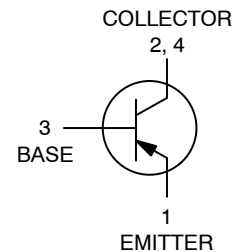

**TO-225
CASE 77-09
STYLE 1**

MARKING DIAGRAM

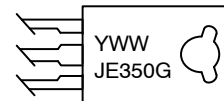

Y = Year
WW = Work Week
JE350 = Device Code
G = Pb–Free Package

ORDERING INFORMATION

| Device | Package | Shipping |
|---------|---------------------|---------------|
| MJE350G | TO-225 (Pb–Free) | 500 Units/Box |

MJE350G

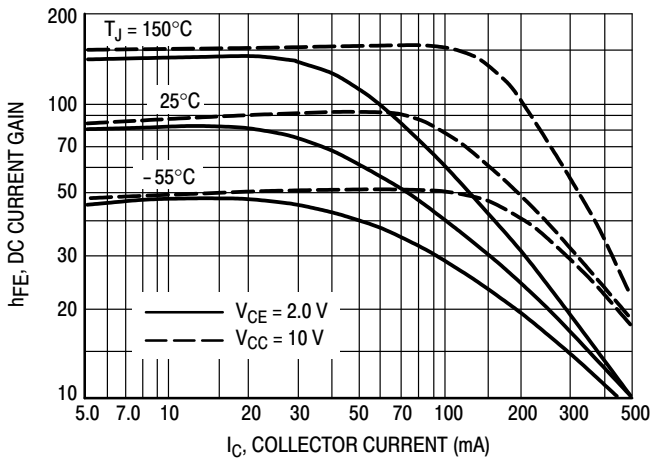

Figure 1. DC Current Gain

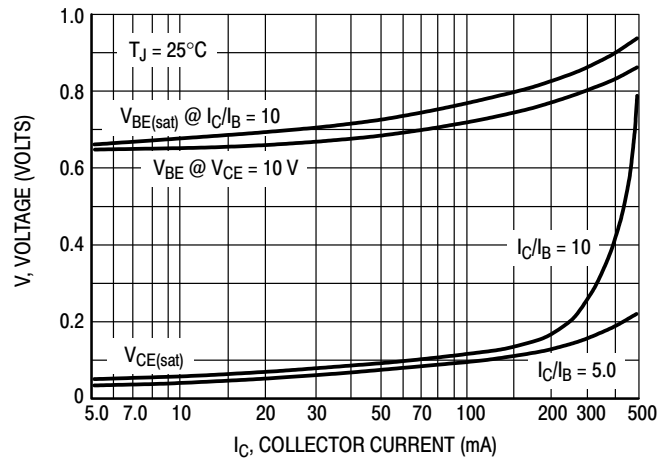

Figure 2. "On" Voltages

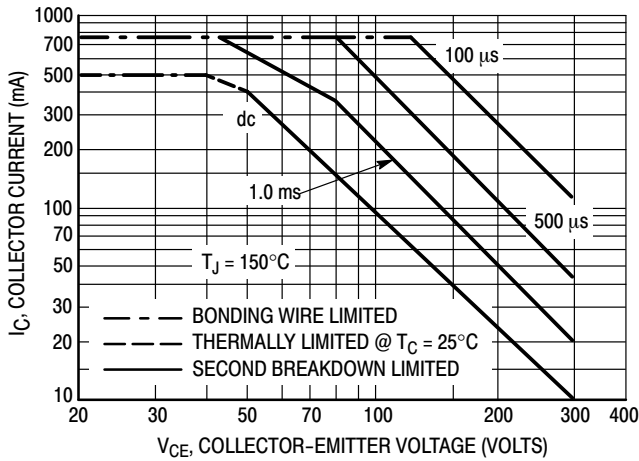

Figure 3. Active-Region Safe Operating Area

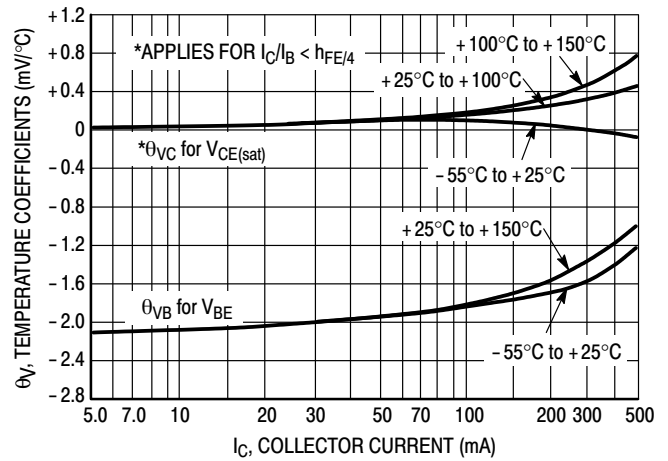

Figure 4. Temperature Coefficients

There are two limitations on the power handling ability of a transistor: average junction temperature and second breakdown. Safe operating area curves indicate $I_C - V_{CE}$ limits of the transistor that must be observed for reliable operation; i.e., the transistor must not be subjected to greater dissipation than the curves indicate.

The data of Figure 3 is based on $T_{J(pk)} = 150^\circ\text{C}$; T_C is variable depending on conditions. Second breakdown pulse limits are valid for duty cycles to 10% provided $T_{J(pk)} \leq 150^\circ\text{C}$. At high case temperatures, thermal limitations will reduce the power that can be handled to values less than the limitations imposed by second breakdown.

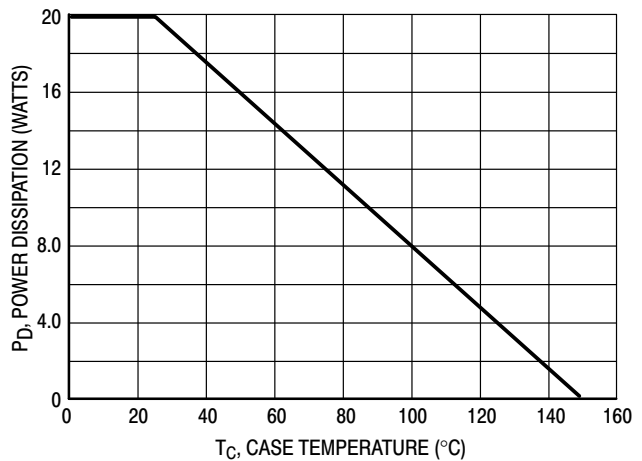
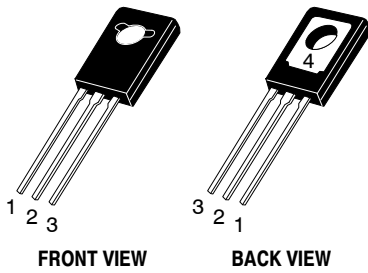

Figure 5. Power Derating

MECHANICAL CASE OUTLINE

PACKAGE DIMENSIONS

ON Semiconductor®



TO-225
CASE 77-09
ISSUE AD

DATE 25 MAR 2015

SCALE 1:1

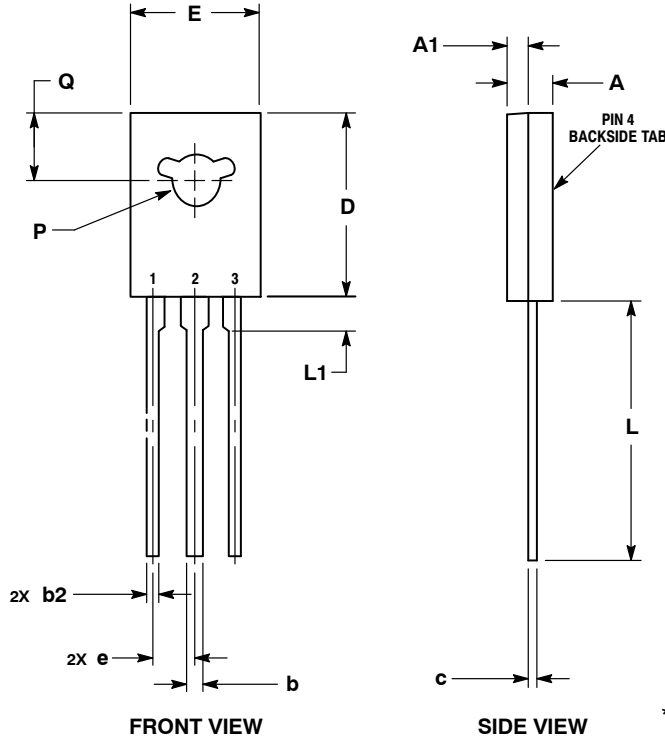

NOTES:

1. DIMENSIONING AND TOLERANCING PER ASME Y14.5M, 1994.
2. CONTROLLING DIMENSION: MILLIMETERS.
3. NUMBER AND SHAPE OF LUGS OPTIONAL.

| DIM | MILLIMETERS | |
|-----|-------------|-------|
| | MIN | MAX |
| A | 2.40 | 3.00 |
| A1 | 1.00 | 1.50 |
| b | 0.60 | 0.90 |
| b2 | 0.51 | 0.88 |
| c | 0.39 | 0.63 |
| D | 10.60 | 11.10 |
| E | 7.40 | 7.80 |
| e | 2.04 | 2.54 |
| L | 14.50 | 16.63 |
| L1 | 1.27 | 2.54 |
| P | 2.90 | 3.30 |
| Q | 3.80 | 4.20 |

GENERIC MARKING DIAGRAM*

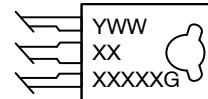

- Y = Year
- WW = Work Week
- XXXXX = Device Code
- G = Pb-Free Package

*This information is generic. Please refer to device data sheet for actual part marking. Pb-Free indicator, "G" or microdot "µ", may or may not be present.

- | | | | | |
|---|---|---|---|---|
| <p>STYLE 1: PIN 1. EMITTER 2., 4. COLLECTOR 3. BASE</p> | <p>STYLE 2: PIN 1. CATHODE 2., 4. ANODE 3. GATE</p> | <p>STYLE 3: PIN 1. BASE 2., 4. COLLECTOR 3. EMITTER</p> | <p>STYLE 4: PIN 1. ANODE 1 2., 4. ANODE 2 3. GATE</p> | <p>STYLE 5: PIN 1. MT 1 2., 4. MT 2 3. GATE</p> |
| <p>STYLE 6: PIN 1. CATHODE 2., 4. GATE 3. ANODE</p> | <p>STYLE 7: PIN 1. MT 1 2., 4. GATE 3. MT 2</p> | <p>STYLE 8: PIN 1. SOURCE 2., 4. GATE 3. DRAIN</p> | <p>STYLE 9: PIN 1. GATE 2., 4. DRAIN 3. SOURCE</p> | <p>STYLE 10: PIN 1. SOURCE 2., 4. DRAIN 3. GATE</p> |

| | | |
|-------------------------|--------------------|--|
| DOCUMENT NUMBER: | 98ASB42049B | Electronic versions are uncontrolled except when accessed directly from the Document Repository. Printed versions are uncontrolled except when stamped "CONTROLLED COPY" in red. |
| DESCRIPTION: | TO-225 | PAGE 1 OF 1 |

ON Semiconductor and are trademarks of Semiconductor Components Industries, LLC dba ON Semiconductor or its subsidiaries in the United States and/or other countries. ON Semiconductor reserves the right to make changes without further notice to any products herein. ON Semiconductor makes no warranty, representation or guarantee regarding the suitability of its products for any particular purpose, nor does ON Semiconductor assume any liability arising out of the application or use of any product or circuit, and specifically disclaims any and all liability, including without limitation special, consequential or incidental damages. ON Semiconductor does not convey any license under its patent rights nor the rights of others.

ON Semiconductor and  are trademarks of Semiconductor Components Industries, LLC dba ON Semiconductor or its subsidiaries in the United States and/or other countries. ON Semiconductor owns the rights to a number of patents, trademarks, copyrights, trade secrets, and other intellectual property. A listing of ON Semiconductor's product/patent coverage may be accessed at www.onsemi.com/site/pdf/Patent-Marking.pdf. ON Semiconductor reserves the right to make changes without further notice to any products herein. ON Semiconductor makes no warranty, representation or guarantee regarding the suitability of its products for any particular purpose, nor does ON Semiconductor assume any liability arising out of the application or use of any product or circuit, and specifically disclaims any and all liability, including without limitation special, consequential or incidental damages. Buyer is responsible for its products and applications using ON Semiconductor products, including compliance with all laws, regulations and safety requirements or standards, regardless of any support or applications information provided by ON Semiconductor. "Typical" parameters which may be provided in ON Semiconductor data sheets and/or specifications can and do vary in different applications and actual performance may vary over time. All operating parameters, including "Typicals" must be validated for each customer application by customer's technical experts. ON Semiconductor does not convey any license under its patent rights nor the rights of others. ON Semiconductor products are not designed, intended, or authorized for use as a critical component in life support systems or any FDA Class 3 medical devices or medical devices with a same or similar classification in a foreign jurisdiction or any devices intended for implantation in the human body. Should Buyer purchase or use ON Semiconductor products for any such unintended or unauthorized application, Buyer shall indemnify and hold ON Semiconductor and its officers, employees, subsidiaries, affiliates, and distributors harmless against all claims, costs, damages, and expenses, and reasonable attorney fees arising out of, directly or indirectly, any claim of personal injury or death associated with such unintended or unauthorized use, even if such claim alleges that ON Semiconductor was negligent regarding the design or manufacture of the part. ON Semiconductor is an Equal Opportunity/Affirmative Action Employer. This literature is subject to all applicable copyright laws and is not for resale in any manner.

PUBLICATION ORDERING INFORMATION

LITERATURE FULFILLMENT:

Email Requests to: orderlit@onsemi.com

ON Semiconductor Website: www.onsemi.com

TECHNICAL SUPPORT

North American Technical Support:
Voice Mail: 1 800-282-9855 Toll Free USA/Canada
Phone: 011 421 33 790 2910

Europe, Middle East and Africa Technical Support:

Phone: 00421 33 790 2910

For additional information, please contact your local Sales Representative

Mouser Electronics

Authorized Distributor

Click to View Pricing, Inventory, Delivery & Lifecycle Information:

[ON Semiconductor:](#)

[MJE350](#) [MJE350G](#) [MJE350STU](#)