

GENERAL DESCRIPTION

This Power MOSFET is designed for low voltage, high speed power switching applications such as switching regulators, converters, solenoid and relay drivers.

FEATURES

- ◆ Silicon Gate for Fast Switching Speeds
- ◆ Low $R_{DS(on)}$ to Minimize On-Losses. Specified at Elevated Temperature
- ◆ Rugged – SOA is Power Dissipation Limited
- ◆ Source-to-Drain Characterized for Use With Inductive Loads

PIN CONFIGURATION

TO-220
Front View

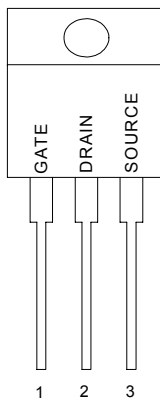

SYMBOL

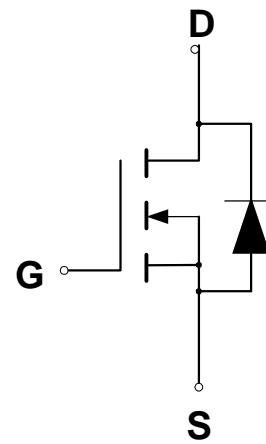

N-Channel MOSFET

ORDERING INFORMATION

Part Number	Package
CMT18N20N220	TO-220

ABSOLUTE MAXIMUM RATINGS

Rating	Symbol	Value	Unit
Drain to Current – Continuous	I_D	18	A
– Pulsed	I_{DM}	72	
Gate-to-Source Voltage – Continue	V_{GS}	± 20	V
– Non-repetitive	V_{GSM}	± 40	V
Total Power Dissipation	P_D	125	W
Derate above 25°C		1.00	W/°C
Operating and Storage Temperature Range	T_J, T_{STG}	-55 to 150	°C
Single Pulse Drain-to-Source Avalanche Energy – $T_J = 25^\circ\text{C}$ ($V_{DD} = 100\text{V}, V_{GS} = 10\text{V}, I_L = 18\text{A}, L = 1.38\text{mH}, R_G = 25\Omega$)	E_{AS}	224	mJ
Thermal Resistance – Junction to Case	θ_{JC}	1.00	°C/W
– Junction to Ambient	θ_{JA}	62.5	
Maximum Lead Temperature for Soldering Purposes, 1/8" from case for 10 seconds	T_L	260	°C

(1) Pulse Width and frequency is limited by $T_J(\text{max})$ and thermal response

ELECTRICAL CHARACTERISTICS

Unless otherwise specified, $T_J = 25^\circ\text{C}$.

Characteristic	Symbol	CMT18N20			Units
		Min	Typ	Max	
Drain-Source Breakdown Voltage ($V_{GS} = 0\text{ V}$, $I_D = 250\ \mu\text{A}$)	$V_{(BR)DSS}$	200			V
Drain-Source Leakage Current ($V_{DS} = \text{Rated } V_{DSS}$, $V_{GS} = 0\text{ V}$) ($V_{DS} = 0.8\text{Rated } V_{DSS}$, $V_{GS} = 0\text{ V}$, $T_J = 125^\circ\text{C}$)	I_{DSS}			0.025 1.0	mA
Gate-Source Leakage Current-Forward ($V_{gsf} = 20\text{ V}$, $V_{DS} = 0\text{ V}$)	I_{GSSF}			100	nA
Gate-Source Leakage Current-Reverse ($V_{gsr} = 20\text{ V}$, $V_{DS} = 0\text{ V}$)	I_{GSSR}			100	nA
Gate Threshold Voltage ($V_{DS} = V_{GS}$, $I_D = 250\ \mu\text{A}$)	$V_{GS(th)}$	2.0		4.0	V
Static Drain-Source On-Resistance ($V_{GS} = 10\text{ V}$, $I_D = 10\text{ A}$) *	$R_{DS(on)}$			0.18	Ω
Drain-Source On-Voltage ($V_{GS} = 10\text{ V}$) ($I_D = 5.0\text{ A}$)	$V_{DS(on)}$			6.0	V
Forward Transconductance ($V_{DS} = 50\text{ V}$, $I_D = 10\text{ A}$) *	g_{FS}	6.8			mhos
Input Capacitance	$(V_{DS} = 25\text{ V}$, $V_{GS} = 0\text{ V}$, $f = 1.0\text{ MHz}$)	C_{ISS}		1600	pF
Output Capacitance		C_{OSS}		750	pF
Reverse Transfer Capacitance		C_{RSS}		300	pF
Turn-On Delay Time	$(V_{DD} = 30\text{ V}$, $I_D = 10\text{ A}$, $V_{GS} = 10\text{ V}$, $R_G = 4.7\Omega$) *	$t_{d(on)}$		30	ns
Rise Time		t_r		60	ns
Turn-Off Delay Time		$t_{d(off)}$		80	ns
Fall Time		t_f		60	ns
Total Gate Charge	$(V_{DS} = 0.8\text{Rated } V_{DSS}$, $I_D = \text{Rated } I_D$, $V_{GS} = 10\text{ V}$) *	Q_g		36	nC
Gate-Source Charge		Q_{gs}		16	nC
Gate-Drain Charge		Q_{gd}		26	nC
Internal Drain Inductance (Measured from the drain lead 0.25" from package to center of die)	L_D		4.5		nH
Internal Drain Inductance (Measured from the source lead 0.25" from package to source bond pad)	L_S		7.5		nH
SOURCE-DRAIN DIODE CHARACTERISTICS					
Forward On-Voltage(1)	$(I_S = \text{Rated } I_D$, $dI_S/dt = 100\text{A}/\mu\text{s}$)	V_{SD}		1.5	V
Forward Turn-On Time		t_{on}		**	ns
Reverse Recovery Time		t_{rr}		450	ns

* Pulse Test: Pulse Width $\leq 300\mu\text{s}$, Duty Cycle $\leq 2\%$

** Negligible, Dominated by circuit inductance

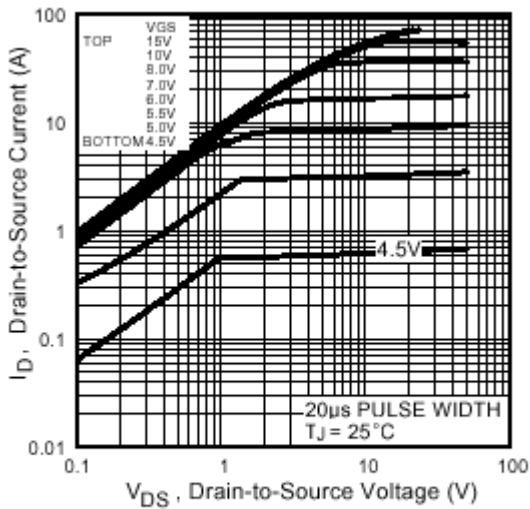
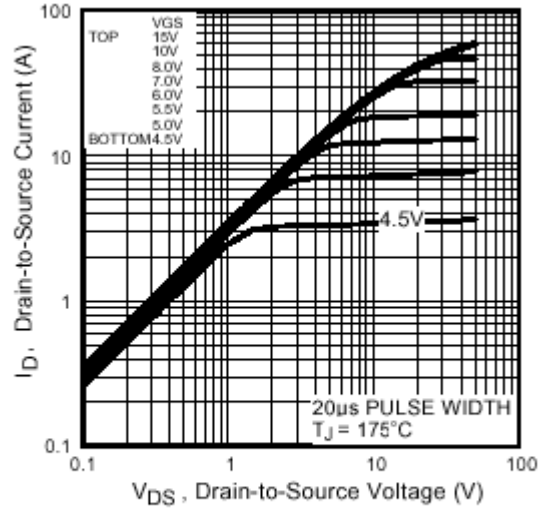
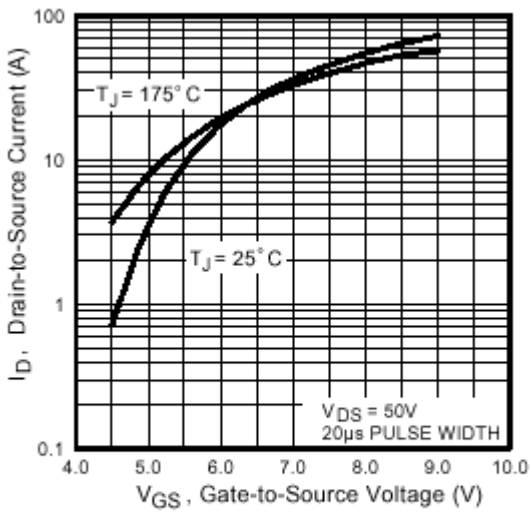
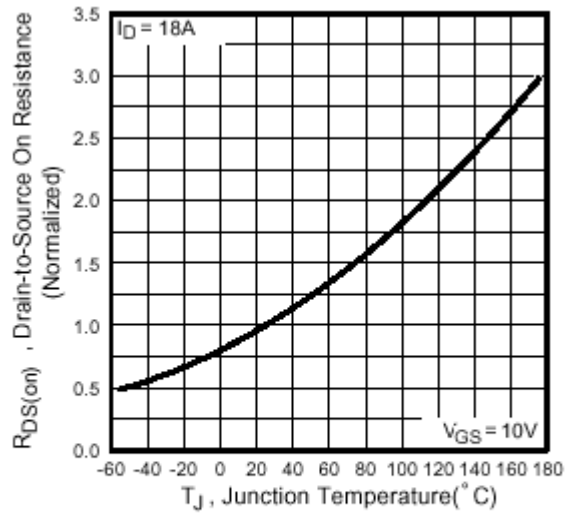
TYPICAL ELECTRICAL CHARACTERISTICS

Fig 1. Typical Output Characteristics

Fig 2. Typical Output Characteristics

Fig 3. Typical Transfer Characteristics

Fig 4. Normalized On-Resistance Vs. Temperature

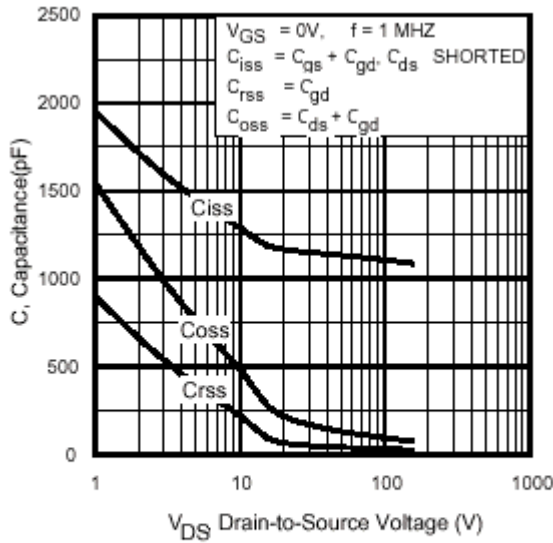

Fig 5. Typical Capacitance Vs. Drain-to-Source Voltage

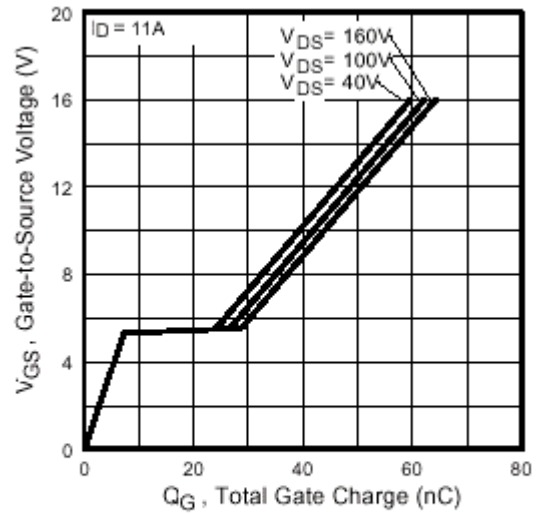

Fig 6. Typical Gate Charge Vs. Gate-to-Source Voltage

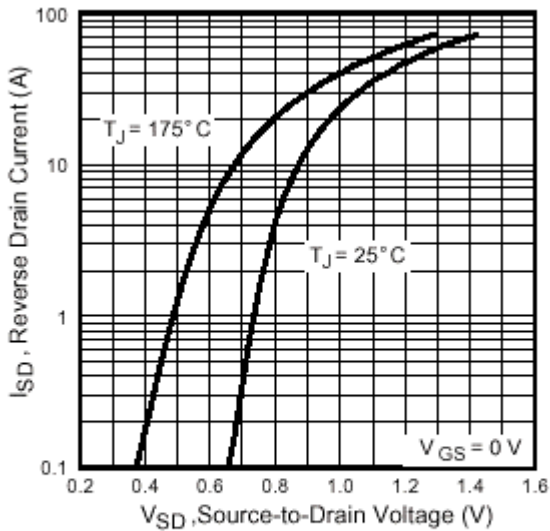

Fig 7. Typical Source-Drain Diode Forward Voltage

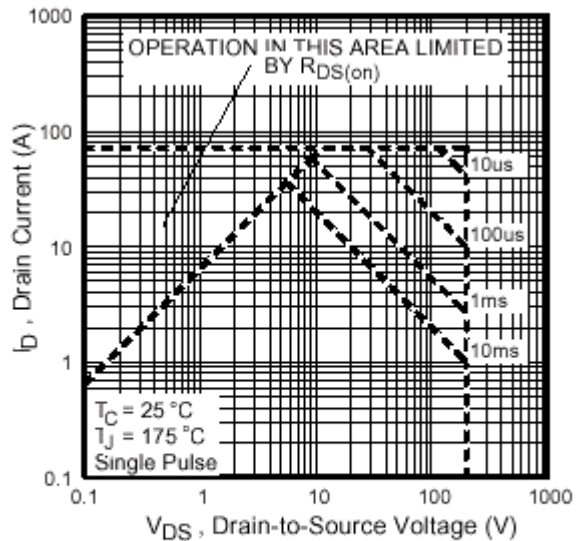

Fig 8. Maximum Safe Operating Area

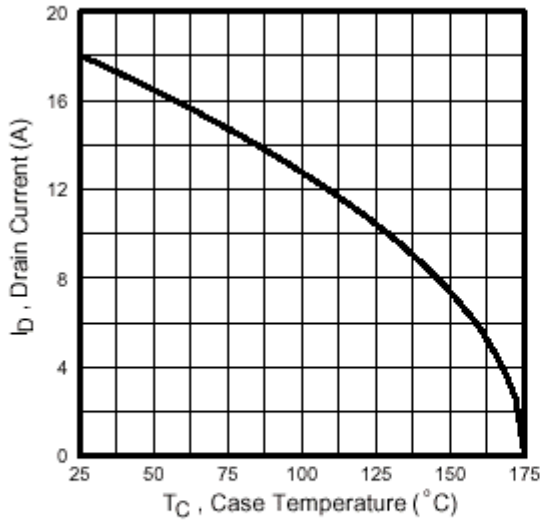

Fig 9. Maximum Drain Current Vs. Case Temperature

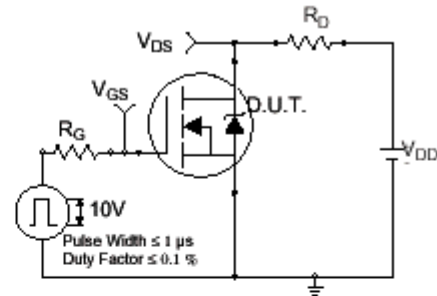

Fig 10a. Switching Time Test Circuit

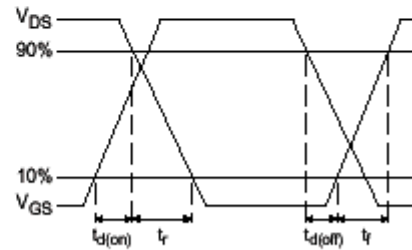

Fig 10b. Switching Time Waveforms

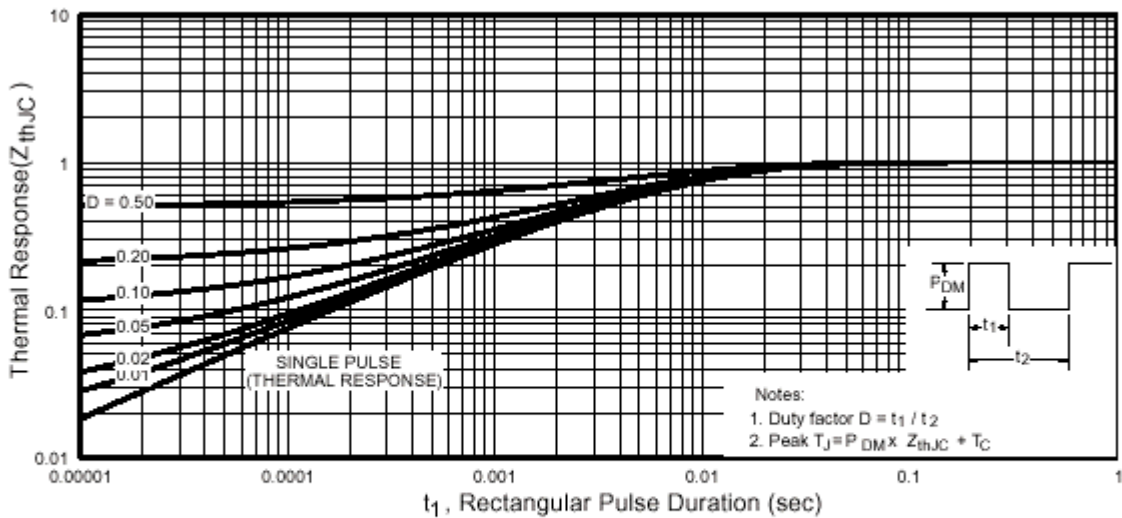
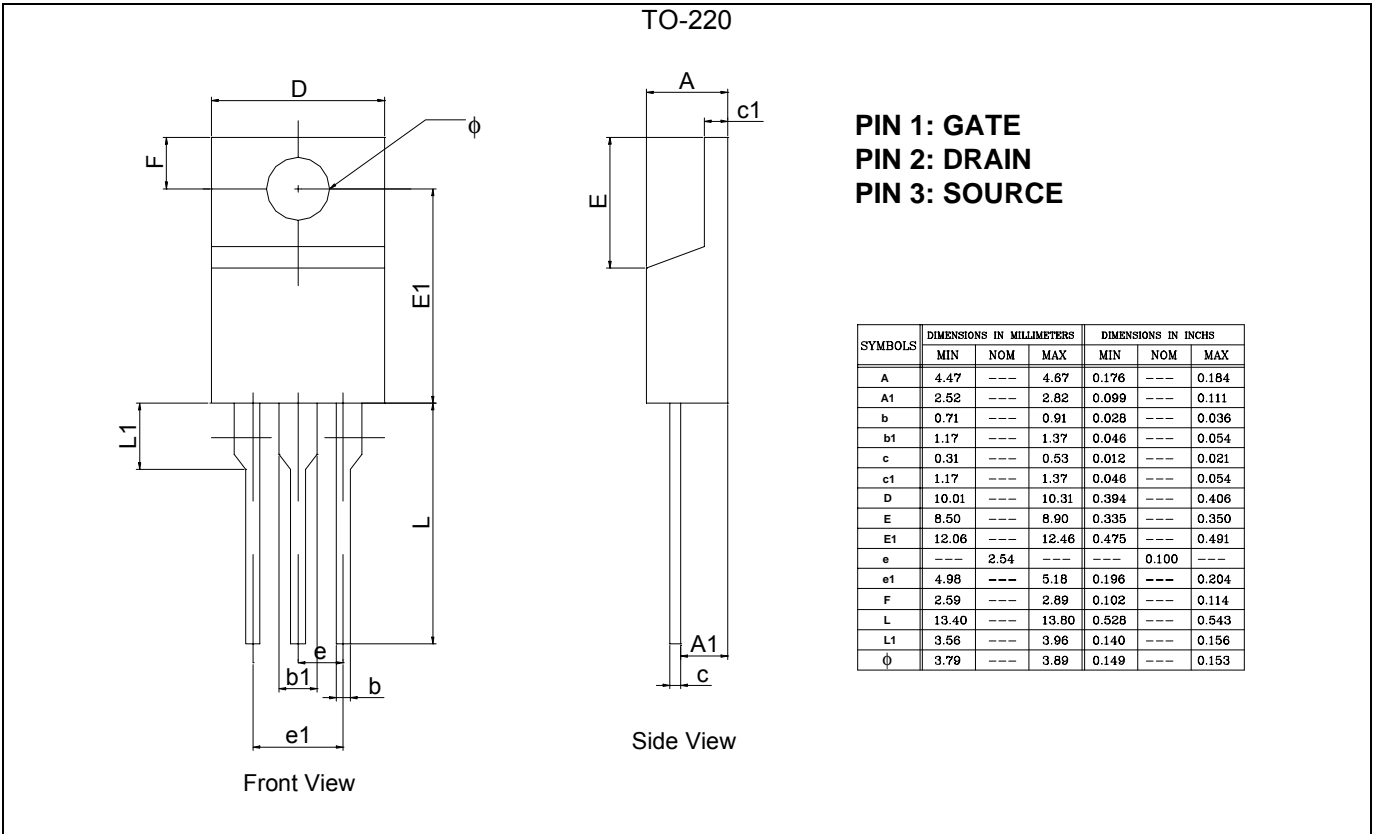

Fig 11. Maximum Effective Transient Thermal Impedance, Junction-to-Case

PACKAGE DIMENSION



IMPORTANT NOTICE

Champion Microelectronic Corporation (CMC) reserves the right to make changes to its products or to discontinue any integrated circuit product or service without notice, and advises its customers to obtain the latest version of relevant information to verify, before placing orders, that the information being relied on is current.

A few applications using integrated circuit products may involve potential risks of death, personal injury, or severe property or environmental damage. CMC integrated circuit products are not designed, intended, authorized, or warranted to be suitable for use in life-support applications, devices or systems or other critical applications. Use of CMC products in such applications is understood to be fully at the risk of the customer. In order to minimize risks associated with the customer's applications, the customer should provide adequate design and operating safeguards.

HsinChu Headquarter

5F, No. 11, Park Avenue II,
Science-Based Industrial Park,
HsinChu City, Taiwan
TEL: +886-3-567 9979
FAX: +886-3-567 9909

Sales & Marketing

11F, No. 306-3, SEC. 1, Ta Tung Road,
Hsichih, Taipei Hsien 221, Taiwan
TEL: +886-2-8692 1591
FAX: +886-2-8692 1596

Copyright © Each Manufacturing Company.

All Datasheets cannot be modified without permission.

This datasheet has been download from :

www.AllDataSheet.com

100% Free DataSheet Search Site.

Free Download.

No Register.

Fast Search System.

www.AllDataSheet.com