

NTMFS4955N

MOSFET – Power, Single, N-Channel, SO-8 FL 30 V, 48 A

Features

- Low $R_{DS(on)}$ to Minimize Conduction Losses
- Low Capacitance to Minimize Driver Losses
- Optimized Gate Charge to Minimize Switching Losses
- Optimized for 5 V, 12 V Gate Drives
- These Devices are Pb-Free, Halogen Free/BFR Free and are RoHS Compliant

Applications

- CPU Power Delivery
- DC-DC Converters

MAXIMUM RATINGS ($T_J = 25^\circ\text{C}$ unless otherwise stated)

Parameter	Symbol	Value	Unit	
Drain-to-Source Voltage	V_{DS}	30	V	
Gate-to-Source Voltage	V_{GS}	± 20	V	
Continuous Drain Current $R_{\theta JA}$ (Note 1)	I_D	$T_A = 25^\circ\text{C}$	16.7	A
		$T_A = 100^\circ\text{C}$	10.5	
Power Dissipation $R_{\theta JA}$ (Note 1)	P_D	2.70	W	
Continuous Drain Current $R_{\theta JA} \leq 10$ s (Note 1)	I_D	$T_A = 25^\circ\text{C}$	25.2	A
		$T_A = 100^\circ\text{C}$	15.9	
Power Dissipation $R_{\theta JA} \leq 10$ s (Note 1)	P_D	6.16	W	
Continuous Drain Current $R_{\theta JA}$ (Note 2)	I_D	$T_A = 25^\circ\text{C}$	9.7	A
		$T_A = 100^\circ\text{C}$	6.2	
Power Dissipation $R_{\theta JA}$ (Note 2)	P_D	0.92	W	
Continuous Drain Current $R_{\theta JC}$ (Note 1)	I_D	$T_C = 25^\circ\text{C}$	48	A
		$T_C = 100^\circ\text{C}$	30	
Power Dissipation $R_{\theta JC}$ (Note 1)	P_D	23.2	W	
Pulsed Drain Current	$T_A = 25^\circ\text{C}, t_p = 10 \mu\text{s}$	I_{DM}	210	A
Current Limited by Package	$T_A = 25^\circ\text{C}$	I_{Dmax}	100	A
Operating Junction and Storage Temperature	T_J, T_{STG}	-55 to +150		$^\circ\text{C}$
Source Current (Body Diode)	I_S	21		A
Drain to Source DV/DT	dV/dt	6.0		V/ns



ON Semiconductor®

<http://onsemi.com>

$V_{(BR)DSS}$	$R_{DS(ON)}$ MAX	I_D MAX
30 V	5.6 m Ω @ 10 V	48 A
	8.5 m Ω @ 4.5 V	

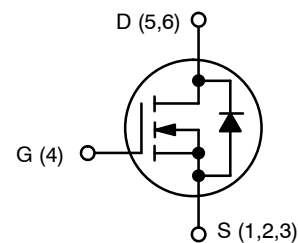

N-CHANNEL MOSFET

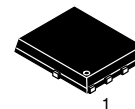

SO-8 FLAT LEAD
CASE 488AA
STYLE 1

MARKING DIAGRAM

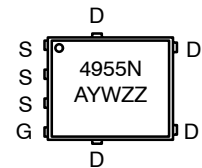

- A = Assembly Location
- Y = Year
- W = Work Week
- ZZ = Lot Traceability

ORDERING INFORMATION

Device	Package	Shipping†
NTMFS4955NT1G	SO-8 FL (Pb-Free)	1500 / Tape & Reel
NTMFS4955NT3G	SO-8 FL (Pb-Free)	5000 / Tape & Reel

†For information on tape and reel specifications, including part orientation and tape sizes, please refer to our Tape and Reel Packaging Specifications Brochure, BRD8011/D.

NTMFS4955N

MAXIMUM RATINGS (T_J = 25°C unless otherwise stated)

Parameter	Symbol	Value	Unit
Single Pulse Drain-to-Source Avalanche Energy (T _J = 25°C, V _{DD} = 24 V, V _{GS} = 10 V, I _L = 26 A _{pk} , L = 0.1 mH, R _G = 25 Ω)	E _{AS}	34	mJ
Lead Temperature for Soldering Purposes (1/8" from case for 10 s)	T _L	260	°C

Stresses exceeding Maximum Ratings may damage the device. Maximum Ratings are stress ratings only. Functional operation above the Recommended Operating Conditions is not implied. Extended exposure to stresses above the Recommended Operating Conditions may affect device reliability.

1. Surface-mounted on FR4 board using 1 sq-in pad, 1 oz Cu.
2. Surface-mounted on FR4 board using the minimum recommended pad size.

THERMAL RESISTANCE MAXIMUM RATINGS

Parameter	Symbol	Value	Unit
Junction-to-Case (Drain)	R _{θJC}	5.4	°C/W
Junction-to-Ambient – Steady State (Note 3)	R _{θJA}	46.3	
Junction-to-Ambient – Steady State (Note 4)	R _{θJA}	136.2	
Junction-to-Ambient – (t ≤ 10 s) (Note 3)	R _{θJA}	20.3	

3. Surface-mounted on FR4 board using 1 sq-in pad, 1 oz Cu.
4. Surface-mounted on FR4 board using the minimum recommended pad size.

ELECTRICAL CHARACTERISTICS (T_J = 25°C unless otherwise specified)

Parameter	Symbol	Test Condition	Min	Typ	Max	Unit
-----------	--------	----------------	-----	-----	-----	------

OFF CHARACTERISTICS

Drain-to-Source Breakdown Voltage	V _{(BR)DSS}	V _{GS} = 0 V, I _D = 250 μA	30			V
Drain-to-Source Breakdown Voltage (transient)	V _{(BR)DSS(t)}	V _{GS} = 0 V, I _{D(aval)} = 11.0 A, T _{case} = 25°C, t _{transient} = 100 ns	34			V
Drain-to-Source Breakdown Voltage Temperature Coefficient	V _{(BR)DSS} /T _J			21		mV/°C
Zero Gate Voltage Drain Current	I _{DSS}	V _{GS} = 0 V, V _{DS} = 24 V			1.0	μA
		T _J = 25°C			10	
Gate-to-Source Leakage Current	I _{GSS}	V _{DS} = 0 V, V _{GS} = ±20 V			±100	nA

ON CHARACTERISTICS (Note 5)

Gate Threshold Voltage	V _{GS(TH)}	V _{GS} = V _{DS} , I _D = 250 μA	1.2	1.7	2.2	V
Negative Threshold Temperature Coefficient	V _{GS(TH)} /T _J			3.9		mV/°C
Drain-to-Source On Resistance	R _{DS(on)}	V _{GS} = 10 V				mΩ
		I _D = 30 A		4.5	5.6	
		I _D = 15 A		4.5		
		V _{GS} = 4.5 V				
		I _D = 30 A		6.8	8.5	
		I _D = 15 A		6.7		
Forward Transconductance	g _{FS}	V _{DS} = 1.5 V, I _D = 15 A		52		S

CHARGES, CAPACITANCES & GATE RESISTANCE

Input Capacitance	C _{ISS}	V _{GS} = 0 V, f = 1 MHz, V _{DS} = 15 V		1264		pF
Output Capacitance	C _{OSS}			483		
Reverse Transfer Capacitance	C _{RSS}			143		
Capacitance Ratio	C _{RSS} /C _{ISS}	V _{GS} = 0 V, V _{DS} = 15 V, f = 1 MHz		0.11	0.22	

5. Pulse Test: pulse width ≤ 300 μs, duty cycle ≤ 2%.
6. Switching characteristics are independent of operating junction temperatures.

NTMFS4955N

ELECTRICAL CHARACTERISTICS ($T_J = 25^\circ\text{C}$ unless otherwise specified)

Parameter	Symbol	Test Condition	Min	Typ	Max	Unit
-----------	--------	----------------	-----	-----	-----	------

CHARGES, CAPACITANCES & GATE RESISTANCE

Total Gate Charge	$Q_{G(TOT)}$	$V_{GS} = 4.5\text{ V}, V_{DS} = 15\text{ V}; I_D = 30\text{ A}$		10.8		nC
Threshold Gate Charge	$Q_{G(TH)}$			2.0		
Gate-to-Source Charge	Q_{GS}			3.8		
Gate-to-Drain Charge	Q_{GD}			4.2		
Total Gate Charge	$Q_{G(TOT)}$	$V_{GS} = 10\text{ V}, V_{DS} = 15\text{ V}; I_D = 30\text{ A}$		21.5		nC

SWITCHING CHARACTERISTICS (Note 6)

Turn-On Delay Time	$t_{d(ON)}$	$V_{GS} = 4.5\text{ V}, V_{DS} = 15\text{ V},$ $I_D = 15\text{ A}, R_G = 3.0\ \Omega$		9.5		ns
Rise Time	t_r			32.7		
Turn-Off Delay Time	$t_{d(OFF)}$			16.4		
Fall Time	t_f			6.2		
Turn-On Delay Time	$t_{d(ON)}$	$V_{GS} = 10\text{ V}, V_{DS} = 15\text{ V},$ $I_D = 15\text{ A}, R_G = 3.0\ \Omega$		7.4		ns
Rise Time	t_r			27.5		
Turn-Off Delay Time	$t_{d(OFF)}$			20.3		
Fall Time	t_f			4.1		

DRAIN-SOURCE DIODE CHARACTERISTICS

Forward Diode Voltage	V_{SD}	$V_{GS} = 0\text{ V},$ $I_S = 30\text{ A}$	$T_J = 25^\circ\text{C}$		0.86	1.1	V
			$T_J = 125^\circ\text{C}$		0.75		
Reverse Recovery Time	t_{RR}	$V_{GS} = 0\text{ V}, dI_S/dt = 100\text{ A}/\mu\text{s},$ $I_S = 30\text{ A}$			25.8		ns
Charge Time	t_a				12.4		
Discharge Time	t_b				13.4		
Reverse Recovery Charge	Q_{RR}				13.6		

PACKAGE PARASITIC VALUES

Source Inductance	L_S	$T_A = 25^\circ\text{C}$		1.00		nH
Drain Inductance	L_D			0.005		nH
Gate Inductance	L_G			1.84		nH
Gate Resistance	R_G			1.0	2.2	Ω

5. Pulse Test: pulse width $\leq 300\ \mu\text{s}$, duty cycle $\leq 2\%$.

6. Switching characteristics are independent of operating junction temperatures.

TYPICAL CHARACTERISTICS

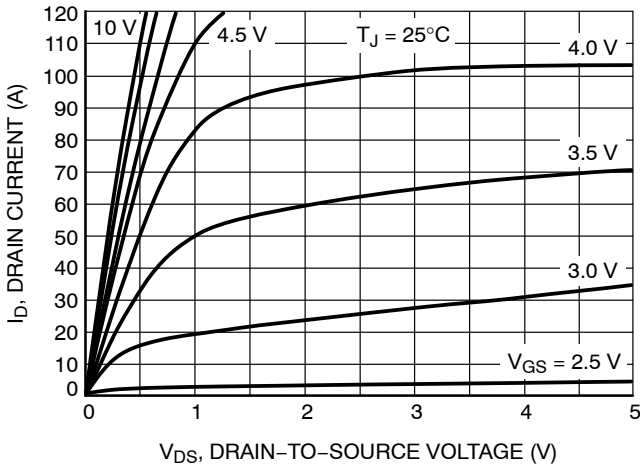

Figure 1. On-Region Characteristics

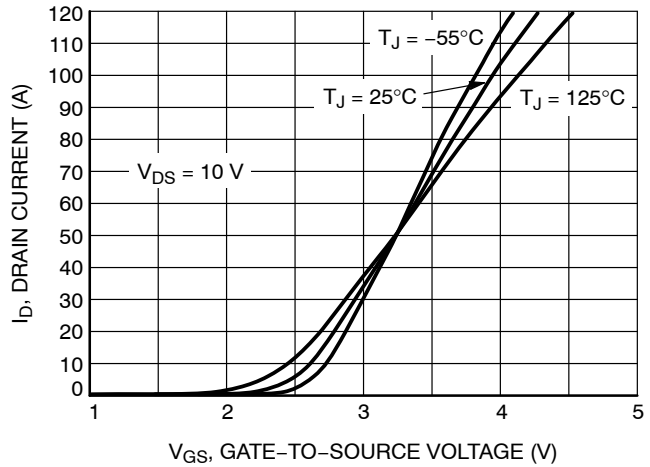

Figure 2. Transfer Characteristics

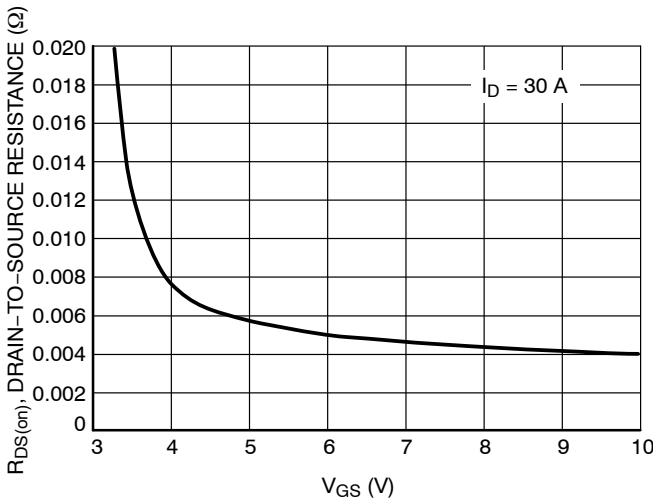

Figure 3. On-Resistance vs. VGS

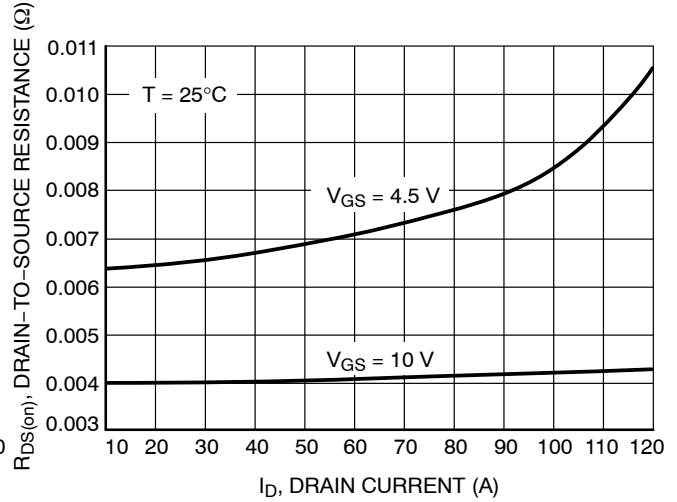

Figure 4. On-Resistance vs. Drain Current and Gate Voltage

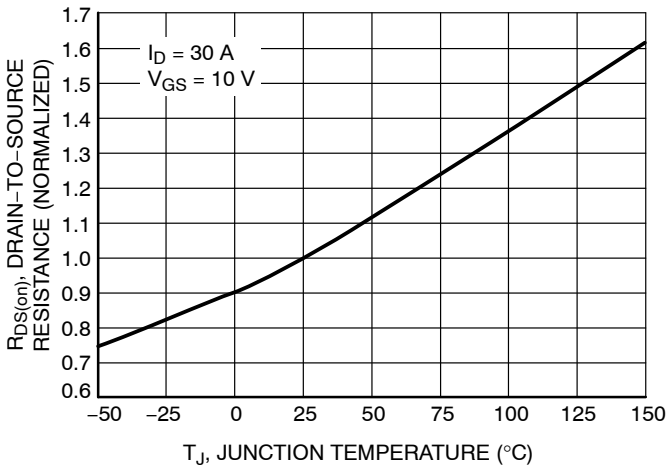

Figure 5. On-Resistance Variation with Temperature

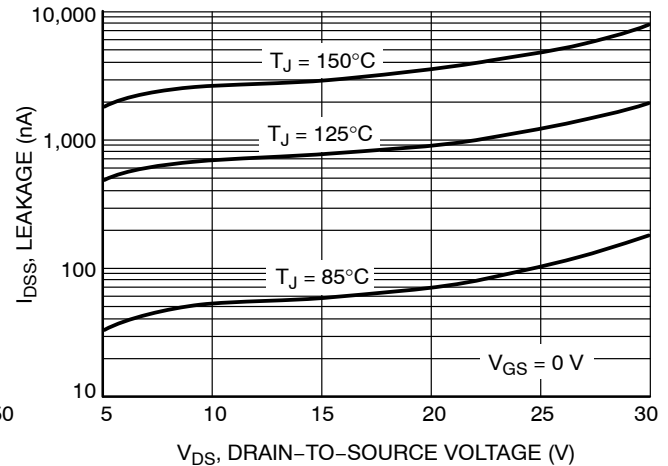

Figure 6. Drain-to-Source Leakage Current vs. Voltage

TYPICAL CHARACTERISTICS

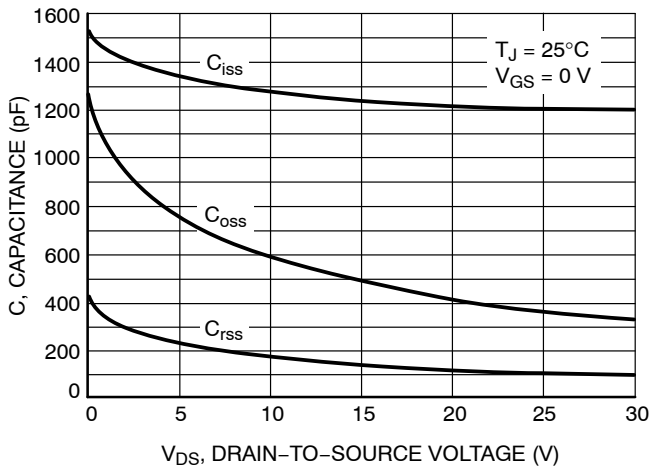

Figure 7. Capacitance Variation

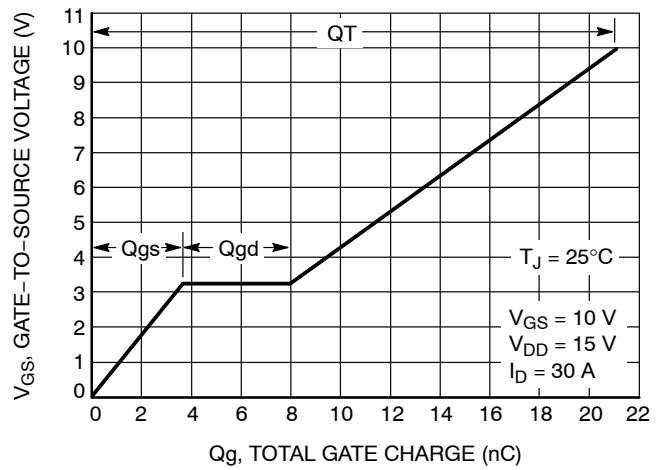

Figure 8. Gate-to-Source and Drain-to-Source Voltage vs. Total Charge

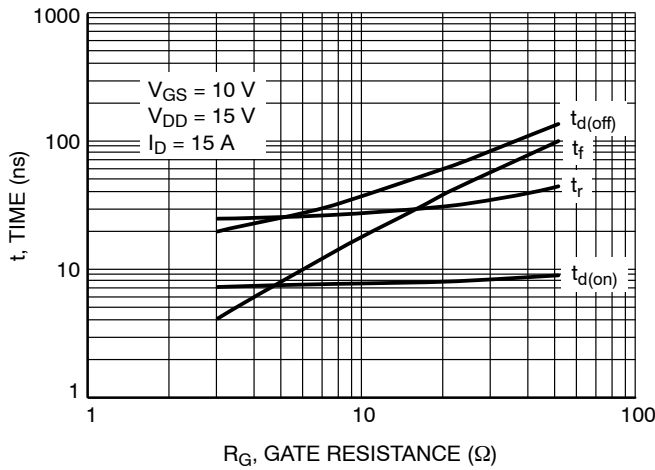

Figure 9. Resistive Switching Time Variation vs. Gate Resistance

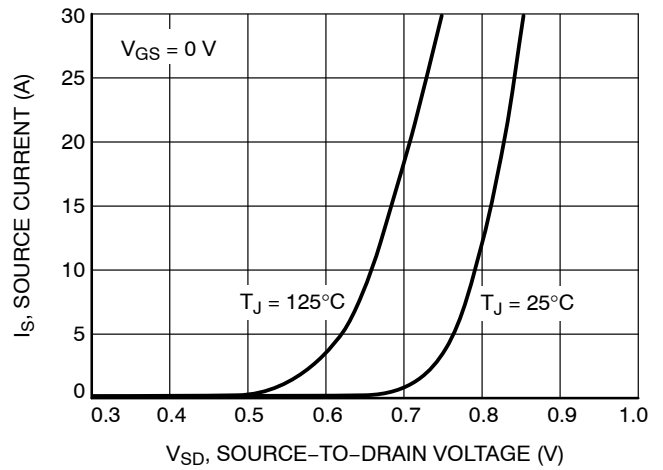

Figure 10. Diode Forward Voltage vs. Current

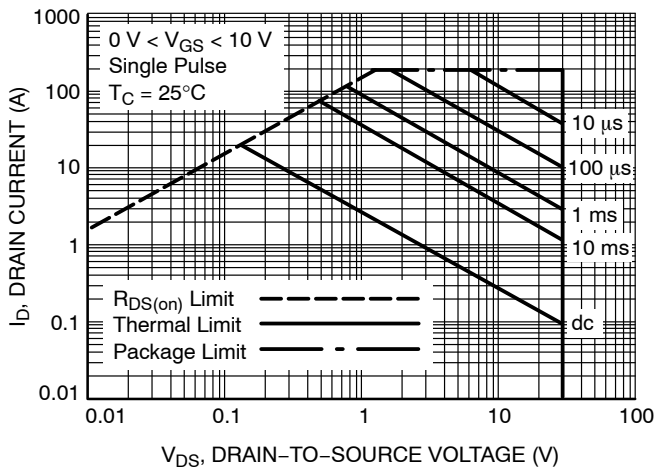

Figure 11. Maximum Rated Forward Biased Safe Operating Area

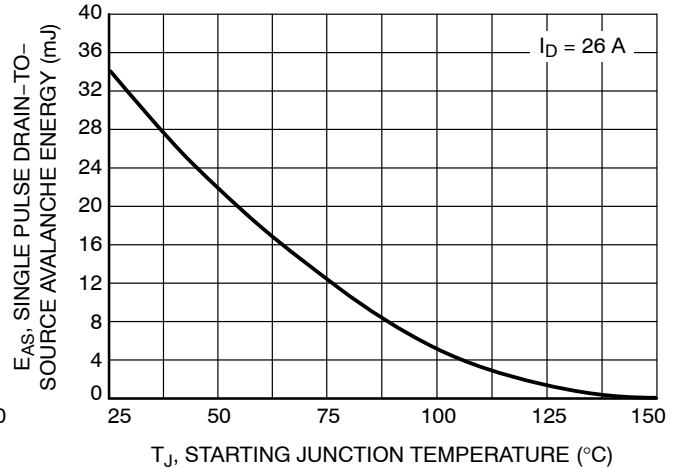

Figure 12. Maximum Avalanche Energy vs. Starting Junction Temperature

NTMFS4955N

TYPICAL CHARACTERISTICS

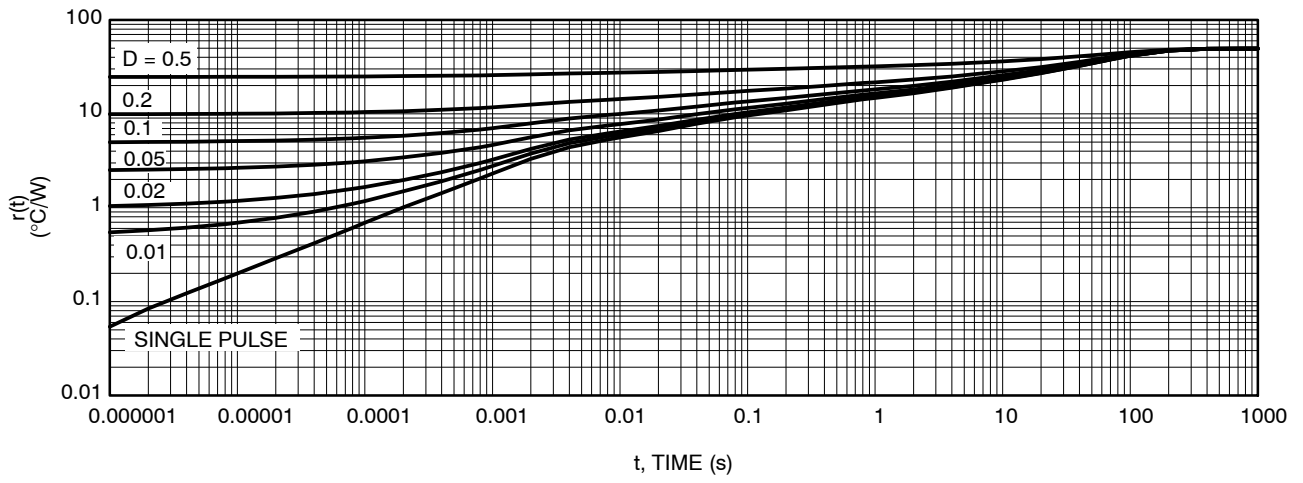

Figure 13. Thermal Response

NTMFS4955N

PACKAGE DIMENSIONS

DFN5 5x6, 1.27P
(SO-8FL)
CASE 488AA
ISSUE H

NOTES:

1. DIMENSIONING AND TOLERANCING PER ASME Y14.5M, 1994.
2. CONTROLLING DIMENSION: MILLIMETER.
3. DIMENSION D1 AND E1 DO NOT INCLUDE MOLD FLASH PROTRUSIONS OR GATE BURRS.

DIM	MILLIMETERS		
	MIN	NOM	MAX
A	0.90	1.00	1.10
A1	0.00	---	0.05
b	0.33	0.41	0.51
c	0.23	0.28	0.33
D	5.15 BSC		
D1	4.70	4.90	5.10
D2	3.80	4.00	4.20
E	6.15 BSC		
E1	5.70	5.90	6.10
E2	3.45	3.65	3.85
e	1.27 BSC		
G	0.51	0.61	0.71
K	1.20	1.35	1.50
L	0.51	0.61	0.71
L1	0.05	0.17	0.20
M	3.00	3.40	3.80
θ	0°	---	12°

STYLE 1:

- PIN 1. SOURCE
- SOURCE
- SOURCE
- GATE
- DRAIN

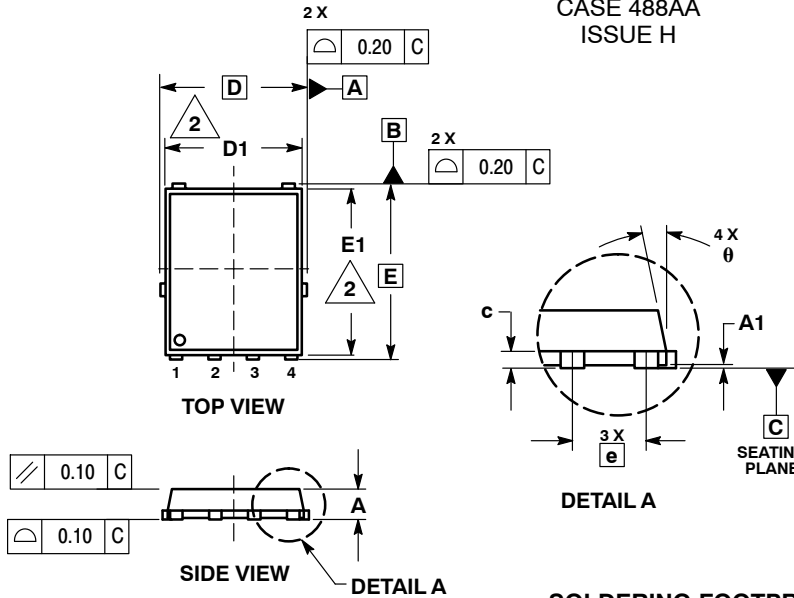

SOLDERING FOOTPRINT*

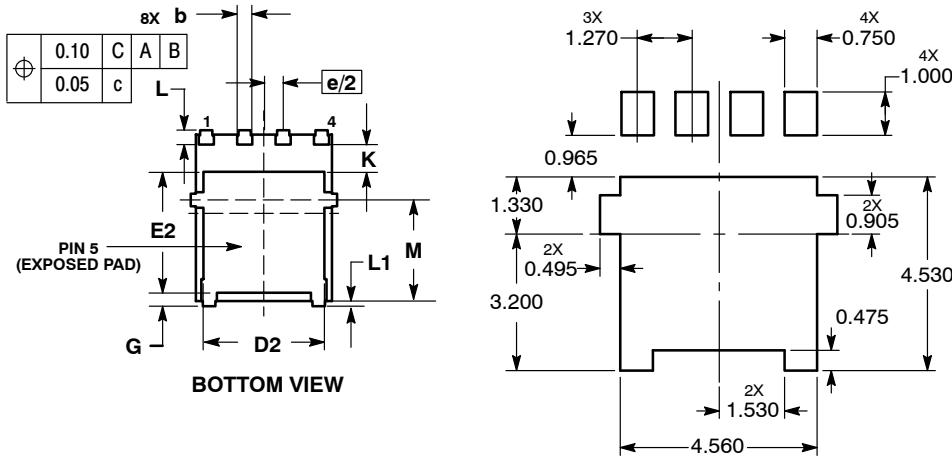

*For additional information on our Pb-Free strategy and soldering details, please download the ON Semiconductor Soldering and Mounting Techniques Reference Manual, SOLDERRM/D.

ON Semiconductor and are registered trademarks of Semiconductor Components Industries, LLC (SCILLC). SCILLC owns the rights to a number of patents, trademarks, copyrights, trade secrets, and other intellectual property. A listing of SCILLC's product/patent coverage may be accessed at www.onsemi.com/site/pdf/Patent-Marking.pdf. SCILLC reserves the right to make changes without further notice to any products herein. SCILLC makes no warranty, representation or guarantee regarding the suitability of its products for any particular purpose, nor does SCILLC assume any liability arising out of the application or use of any product or circuit, and specifically disclaims any and all liability, including without limitation special, consequential or incidental damages. "Typical" parameters which may be provided in SCILLC data sheets and/or specifications can and do vary in different applications and actual performance may vary over time. All operating parameters, including "Typicals" must be validated for each customer application by customer's technical experts. SCILLC does not convey any license under its patent rights nor the rights of others. SCILLC products are not designed, intended, or authorized for use as components in systems intended for surgical implant into the body, or other applications intended to support or sustain life, or for any other application in which the failure of the SCILLC product could create a situation where personal injury or death may occur. Should Buyer purchase or use SCILLC products for any such unintended or unauthorized application, Buyer shall indemnify and hold SCILLC and its officers, employees, subsidiaries, affiliates, and distributors harmless against all claims, costs, damages, and expenses, and reasonable attorney fees arising out of, directly or indirectly, any claim of personal injury or death associated with such unintended or unauthorized use, even if such claim alleges that SCILLC was negligent regarding the design or manufacture of the part. SCILLC is an Equal Opportunity/Affirmative Action Employer. This literature is subject to all applicable copyright laws and is not for resale in any manner.

PUBLICATION ORDERING INFORMATION

LITERATURE FULFILLMENT:

Literature Distribution Center for ON Semiconductor
P.O. Box 5163, Denver, Colorado 80217 USA
Phone: 303-675-2175 or 800-344-3860 Toll Free USA/Canada
Fax: 303-675-2176 or 800-344-3867 Toll Free USA/Canada
Email: orderlit@onsemi.com

N. American Technical Support: 800-282-9855 Toll Free
USA/Canada
Europe, Middle East and Africa Technical Support:
Phone: 421 33 790 2910
Japan Customer Focus Center
Phone: 81-3-5817-1050

ON Semiconductor Website: www.onsemi.com

Order Literature: <http://www.onsemi.com/orderlit>

For additional information, please contact your local Sales Representative

Mouser Electronics

Authorized Distributor

Click to View Pricing, Inventory, Delivery & Lifecycle Information:

[ON Semiconductor:](#)

[NTMFS4C55NT1G](#) [NTMFS4C55NT3G](#)