

## High voltage power Schottky rectifier

Datasheet - production data

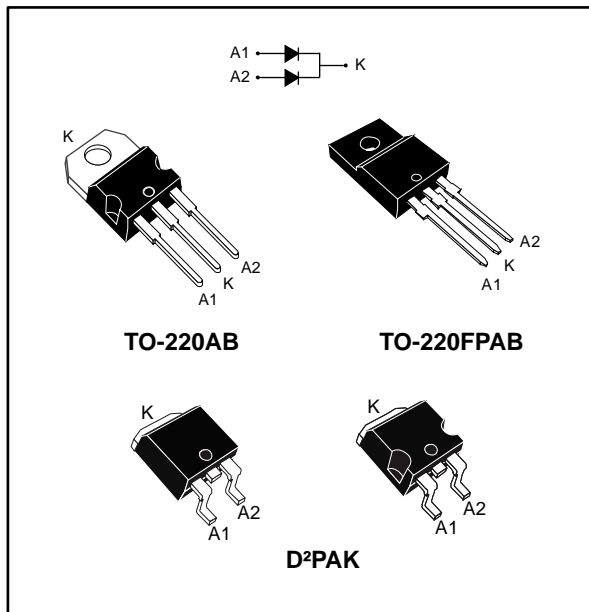

### Description

Schottky barrier rectifier designed for high frequency miniature switched mode power supplies such as adapters and on-board DC/DC converters.

The product is packaged in TO-220AB, TO-220FPAB, and D<sup>2</sup>PAK.

Table 1: Device summary

Symbol	Value
$I_{F(AV)}$	2 x 5 A
$V_{RRM}$	100 V
$V_F$ (typ.)	0.57 V
$T_j$ (max.)	175 °C

### Features

- High junction temperature capability for converters located in confined environment
- Low leakage current at high temperature
- Low static and dynamic losses as a result of the Schottky barrier
- Insulated package: TO-220FPAB
  - Insulating voltage = 2000 V<sub>RMS</sub> sine
- Avalanche capability specified
- ECOPACK<sup>®</sup>2 compliant component for D<sup>2</sup>PAK on demand

# 1 Characteristics

**Table 2: Absolute ratings (limiting values, per diode, at 25 °C, unless otherwise specified)**

Symbol	Parameter			Value	Unit	
V <sub>RRM</sub>	Repetitive peak reverse voltage			100	V	
I <sub>F(RMS)</sub>	Forward rms current			10	A	
I <sub>F(AV)</sub>	Average forward current δ = 0.5, square wave	TO-220AB / D <sup>2</sup> PAK	T <sub>C</sub> = 165 °C	Per diode	5	A
				Per device	10	
		TO-220FPAB	T <sub>C</sub> = 155 °C	Per diode	5	
			T <sub>C</sub> = 150 °C	Per device	10	
I <sub>FSM</sub>	Surge non repetitive forward current		t <sub>p</sub> = 10 ms sinusoidal	180	A	
P <sub>ARM</sub>	Repetitive peak avalanche power		t <sub>p</sub> = 10 μs, T <sub>j</sub> = 125 °C	515	W	
T <sub>stg</sub>	Storage temperature range			-65 to +175	°C	
T <sub>j</sub>	Maximum operating junction temperature <sup>(1)</sup>			175		

**Notes:**

<sup>(1)</sup>(dP<sub>tot</sub>/dT<sub>j</sub>) < (1/R<sub>th(j-a)</sub>) condition to avoid thermal runaway for a diode on its own heatsink.

**Table 3: Thermal parameters**

Symbol	Parameter		Max. value	Unit	
R <sub>th(j-c)</sub>	Junction to case	TO-220FPAB	Per diode	4.5	°C/W
			Total	3.5	
		TO-220AB / D <sup>2</sup> PAK	Per diode	2.2	
			Total	1.3	
R <sub>th(c)</sub>	Coupling	TO-220FPAB	2.5		
		TO-220AB / D <sup>2</sup> PAK	0.3		

When the diodes 1 and 2 are used simultaneously:

$$\Delta T_j (\text{diode1}) = P_{(\text{diode1})} \times R_{\text{th(j-c)}} (\text{per diode}) + P_{(\text{diode2})} \times R_{\text{th(c)}}$$

Table 4: Static electrical characteristics (per diode)

Symbol	Parameter	Test conditions		Min.	Typ.	Max.	Unit
$I_R^{(1)}$	Reverse leakage current	$T_j = 25\text{ °C}$	$V_R = V_{RRM}$	-		3.5	$\mu\text{A}$
		$T_j = 125\text{ °C}$		-	1.3	4.5	$\text{mA}$
$V_F^{(2)}$	Forward voltage drop	$T_j = 25\text{ °C}$	$I_F = 5\text{ A}$	-		0.73	V
		$T_j = 125\text{ °C}$		-	0.57	0.61	
		$T_j = 25\text{ °C}$	$I_F = 10\text{ A}$	-		0.85	
		$T_j = 125\text{ °C}$		-	0.66	0.71	

**Notes:**

<sup>(1)</sup>Pulse test:  $t_p = 5\text{ ms}$ ,  $\delta < 2\%$

<sup>(2)</sup>Pulse test:  $t_p = 380\text{ }\mu\text{s}$ ,  $\delta < 2\%$

To evaluate the conduction losses, use the following equation:

$$P = 0.51 \times I_{F(AV)} + 0.02 \times I_{F(RMS)}^2$$

# 1.1 Characteristics (curves)

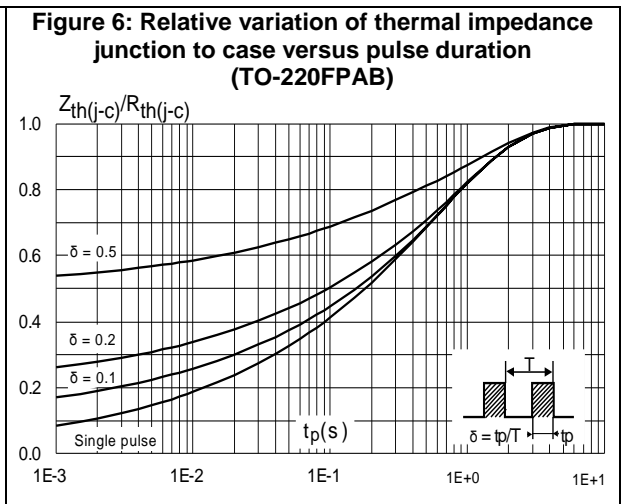
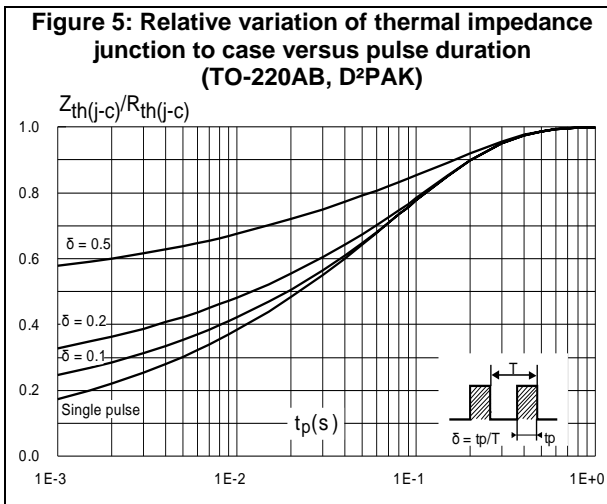
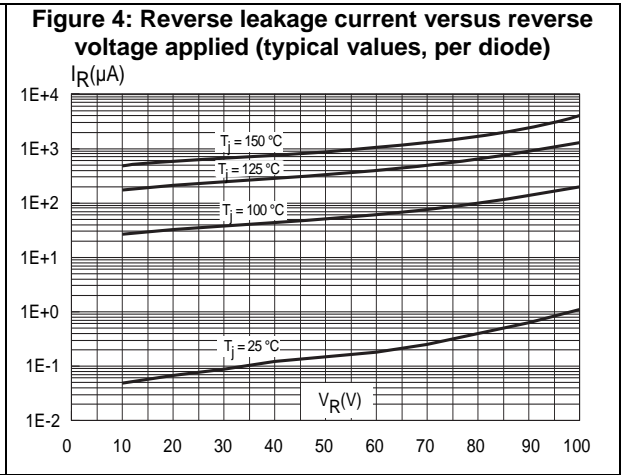
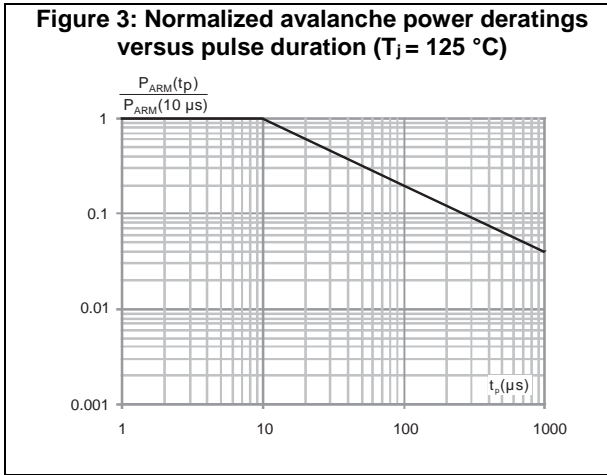
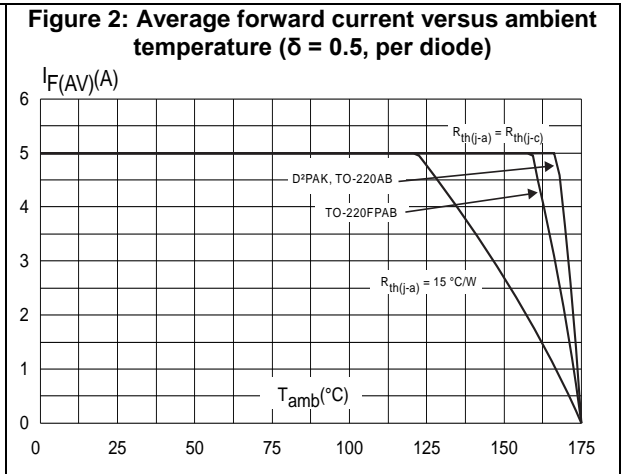
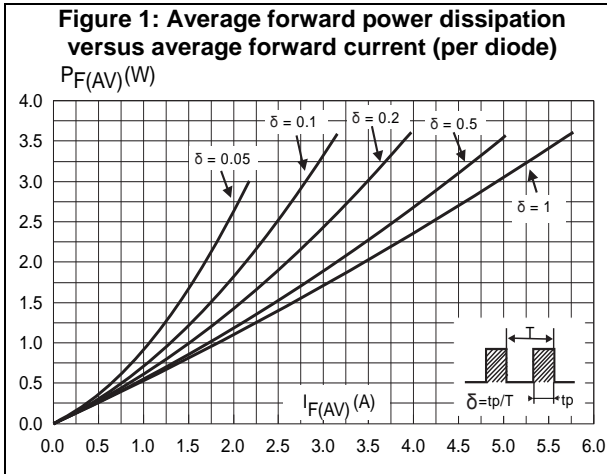

Figure 7: Junction capacitance versus reverse voltage applied (typical values, per diode)

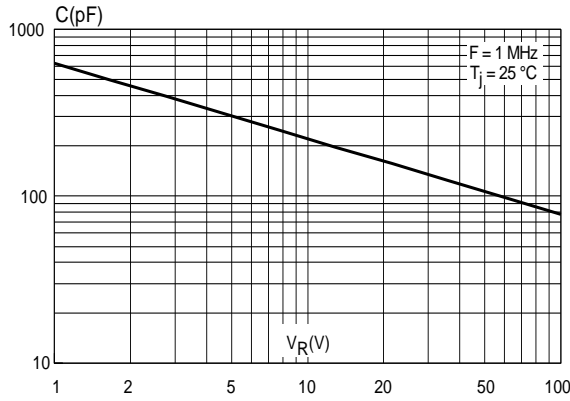

Figure 8: Forward voltage drop versus forward current (maximum values, per diode)

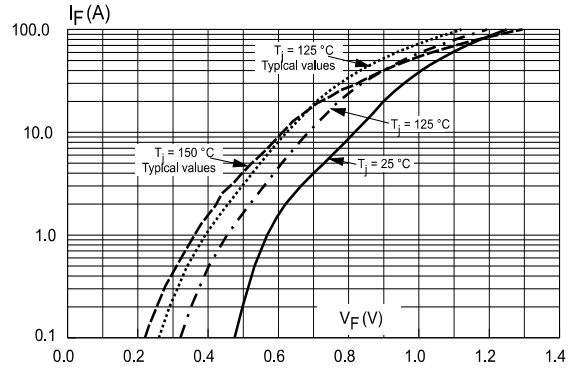
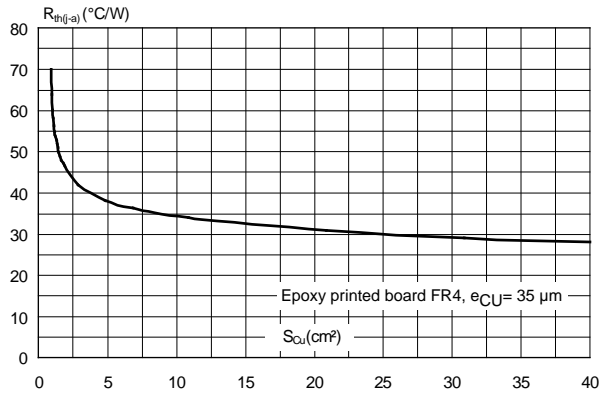

Figure 9: Thermal resistance junction to ambient versus copper surface under tab for D<sup>2</sup>PAK (typical values)



## 2 Package information

In order to meet environmental requirements, ST offers these devices in different grades of ECOPACK® packages, depending on their level of environmental compliance. ECOPACK® specifications, grade definitions and product status are available at: [www.st.com](http://www.st.com). ECOPACK® is an ST trademark.

- Cooling method: by conduction (C)
- Epoxy meets UL 94, V0
- Recommended torque value: 0.55 N·m for TO-220AB
- Maximum torque value: 0.7 N·m for TO-220AB

### 2.1 TO-220AB package information

Figure 10: TO-220AB package outline

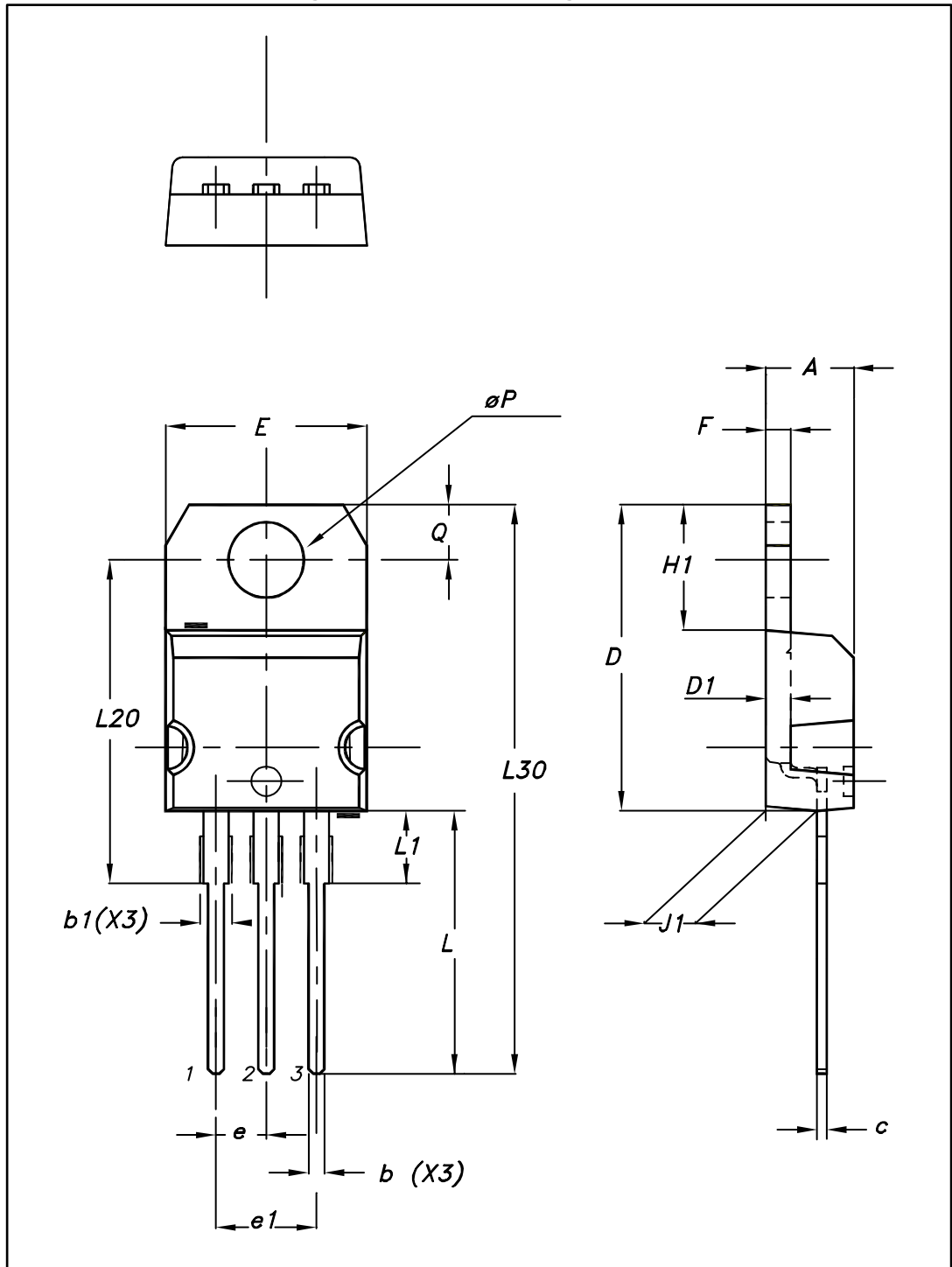

Table 5: TO-220AB package mechanical data

Ref.	Dimensions			
	Millimeters		Inches	
	Min.	Max.	Min.	Max.
A	4.40	4.60	0.173	0.181
b	0.61	0.88	0.240	0.035
b1	1.14	1.70	0.045	0.067
c	0.48	0.70	0.019	0.028
D	15.25	15.75	0.600	0.620
D1	1.27 typ.		0.050 typ.	
E	10.00	10.40	0.394	0.409
e	2.40	2.70	0.094	0.106
e1	4.95	5.15	0.195	0.203
F	1.23	1.32	0.048	0.052
H1	6.20	6.60	0.244	0.260
J1	2.40	2.72	0.094	0.107
L	13.00	14.00	0.512	0.551
L1	3.50	3.93	0.138	0.155
L20	16.40 typ.		0.646 typ.	
L30	28.90 typ.		1.138 typ.	
θP	3.75	3.85	0.148	0.152
Q	2.65	2.95	0.104	0.116



## 2.2 TO-220FPAB package information

Figure 11: TO-220FPAB package outline

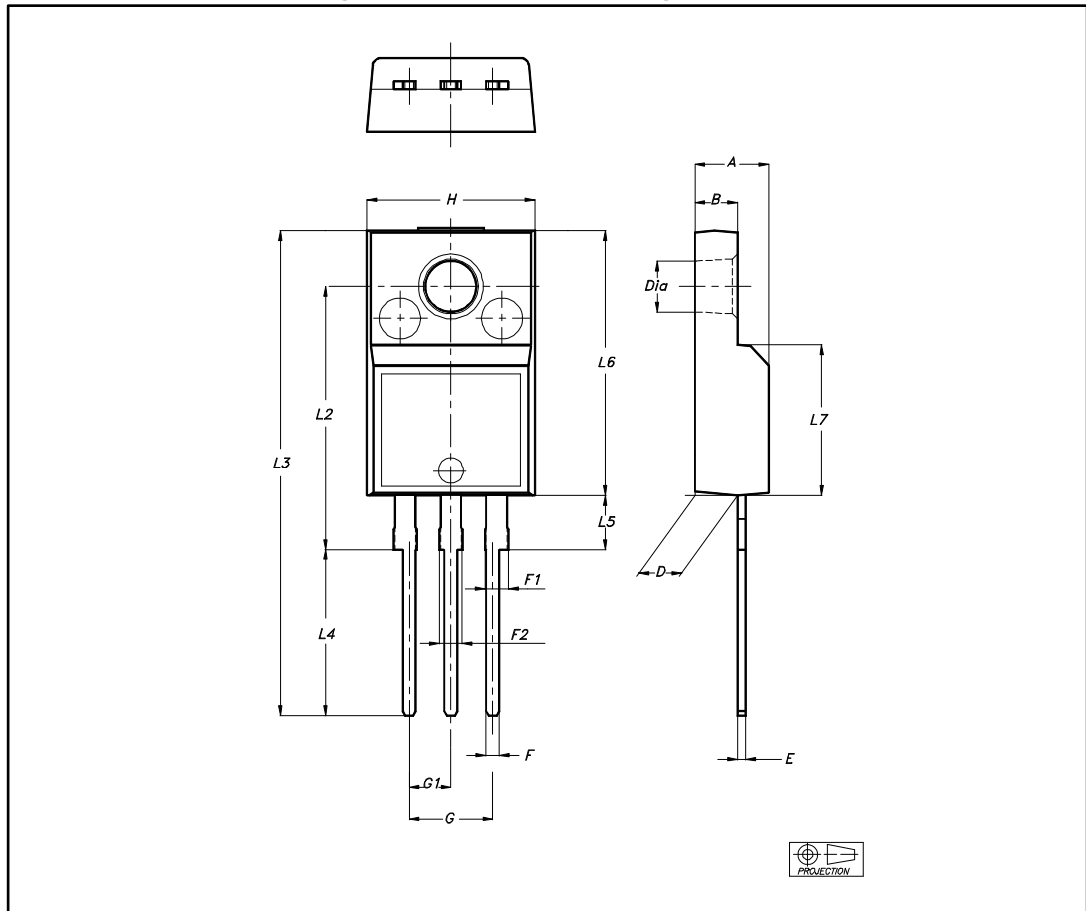
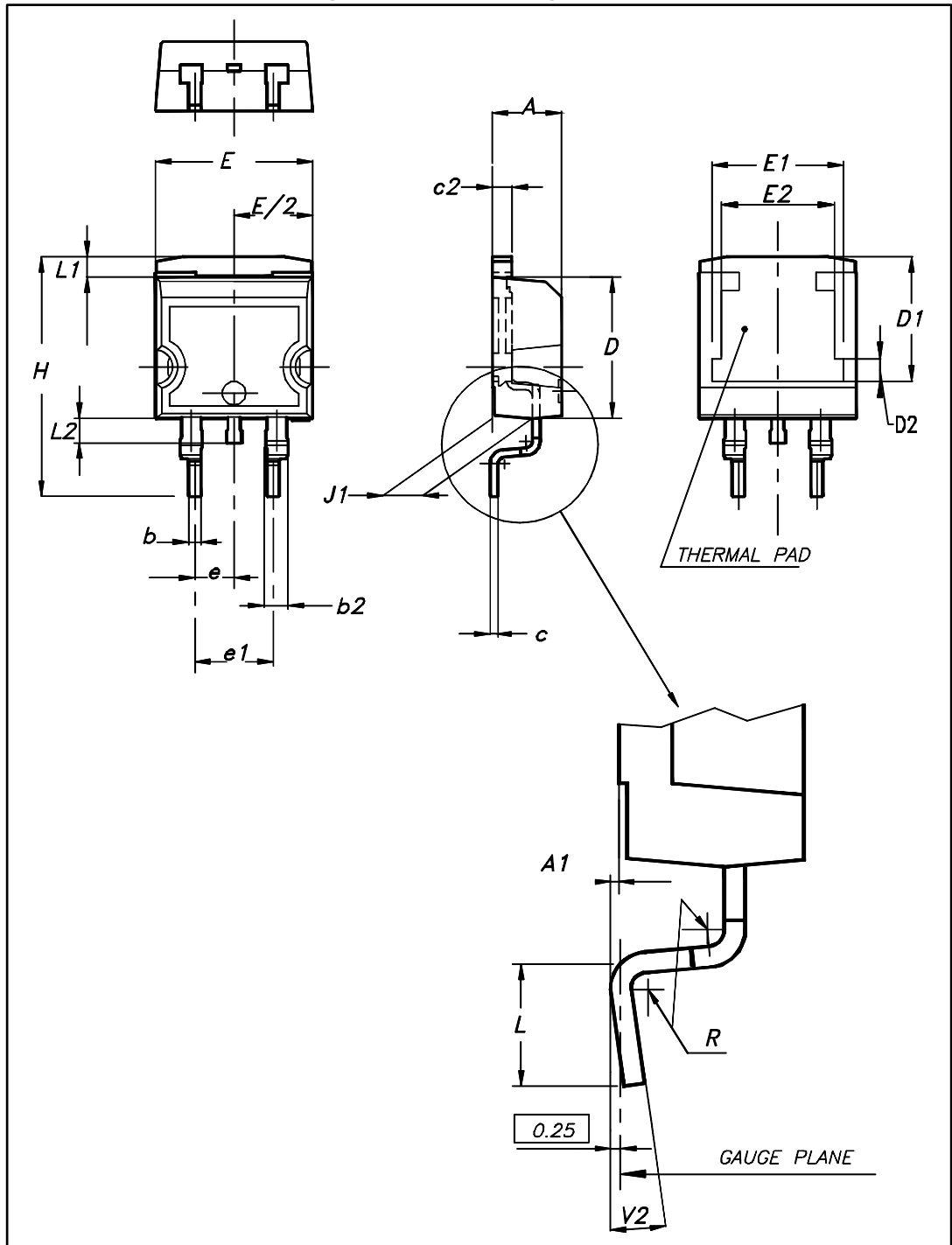

Table 6: TO-220FPAB package mechanical data

Ref.	Dimensions			
	Millimeters		Inches	
	Min.	Max.	Min.	Max.
A	4.40	4.60	0.173	0.181
B	2.5	2.7	0.098	0.106
D	2.5	2.75	0.098	0.108
E	0.45	0.70	0.018	0.028
F	0.75	1	0.030	0.039
F1	1.15	1.70	0.045	0.067
F2	1.15	1.70	0.045	0.067
G	4.95	5.2	0.195	0.205
G1	2.4	2.7	0.094	0.106
H	10	10.4	0.394	0.409
L2	16 typ.		0.63 typ.	
L3	28.60	30.6	1.126	1.205
L4	9.8	10.6	0.386	0.417
L5	2.9	3.6	0.114	0.142
L6	15.9	16.4	0.626	0.646
L7	9	9.3	0.354	0.366
Dia	3	3.2	0.118	0.126

### 2.3 D<sup>2</sup>PAK package information

Figure 12: D<sup>2</sup>PAK package outline



This package drawing may slightly differ from the physical package. However, all the specified dimensions are guaranteed.

Table 7: D<sup>2</sup>PAK package mechanical data

Ref.	Dimensions			
	Millimeters		Inches	
	Min.	Max.	Min.	Max.
A	4.36	4.60	0.172	0.181
A1	0.00	0.25	0.000	0.010
b	0.70	0.93	0.028	0.037
b2	1.14	1.70	0.045	0.067
c	0.38	0.69	0.015	0.027
c2	1.19	1.36	0.047	0.053
D	8.60	9.35	0.339	0.368
D1	6.90	8.00	0.272	0.311
D2	1.10	1.50	0.043	0.060
E	10.00	10.55	0.394	0.415
E1	8.10	8.90	0.319	0.346
E2	6.85	7.25	0.266	0.282
e	2.54 typ.		0.100	
e1	4.88	5.28	0.190	0.205
H	15.00	15.85	0.591	0.624
J1	2.49	2.90	0.097	0.112
L	1.90	2.79	0.075	0.110
L1	1.27	1.65	0.049	0.065
L2	1.30	1.78	0.050	0.070
R	0.4 typ.		0.015	
V2	0°	8°	0°	8°

Figure 13: D<sup>2</sup>PAK recommended footprint (dimensions in mm)

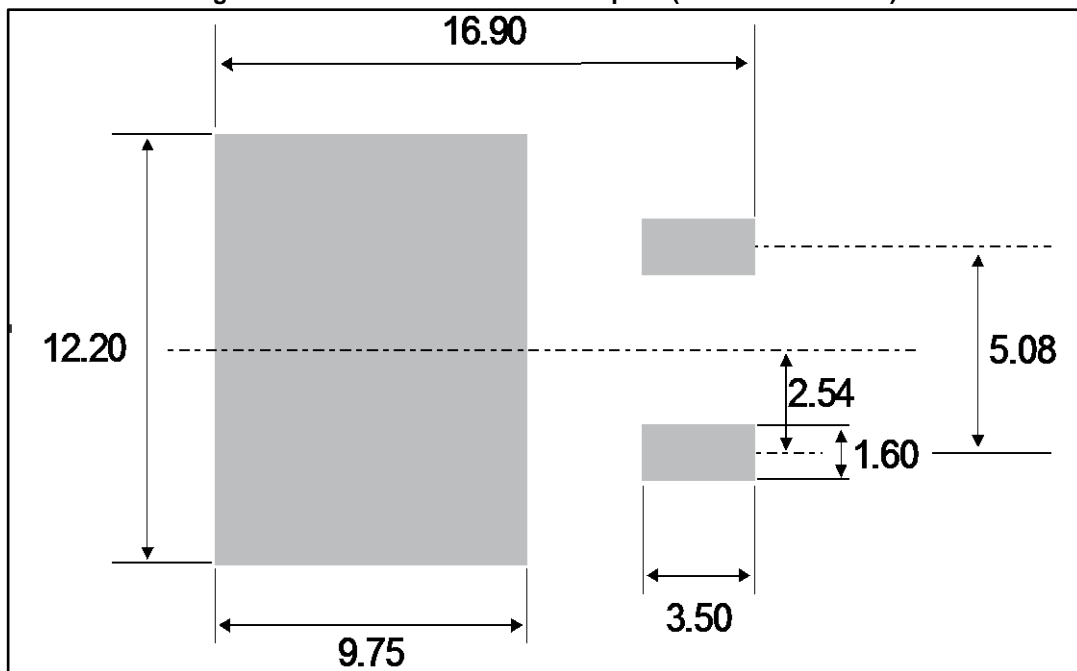

### 3 Ordering information

Table 8: Ordering information

Order code	Marking	Package	Weight	Base qty.	Delivery mode
STPS10H100CT	STPS10H100CT	TO-220AB	1.9 g	50	Tube
STPS10H100CFP	STPS10H100CFP	TO-220FPAB	1.9 g	50	Tube
STPS10H100CG-TR	STPS10H100CG	D <sup>2</sup> PAK	1.38 g	1000	Tape and reel

### 4 Revision history

Table 9: Document revision history

Date	Revision	Changes
20-Dec-2013	1	Recovered contents of document STPS10H100, July 2003, Revision 3F (DocID6476), and removed I <sup>2</sup> PAK package.
17-Oct-2016	2	Updated cover page, and <a href="#">Section 3.1: "Characteristics (curves)"</a> , <a href="#">Section 3: "Characteristics"</a> , <a href="#">Section 5: "Ordering information"</a> and <a href="#">Section 4.4: "D<sup>2</sup>PAK package information"</a> .

**IMPORTANT NOTICE – PLEASE READ CAREFULLY**

STMicroelectronics NV and its subsidiaries ("ST") reserve the right to make changes, corrections, enhancements, modifications, and improvements to ST products and/or to this document at any time without notice. Purchasers should obtain the latest relevant information on ST products before placing orders. ST products are sold pursuant to ST's terms and conditions of sale in place at the time of order acknowledgement.

Purchasers are solely responsible for the choice, selection, and use of ST products and ST assumes no liability for application assistance or the design of Purchasers' products.

No license, express or implied, to any intellectual property right is granted by ST herein.

Resale of ST products with provisions different from the information set forth herein shall void any warranty granted by ST for such product.

ST and the ST logo are trademarks of ST. All other product or service names are the property of their respective owners.

Information in this document supersedes and replaces information previously supplied in any prior versions of this document.

© 2016 STMicroelectronics – All rights reserved

# Mouser Electronics

Authorized Distributor

Click to View Pricing, Inventory, Delivery & Lifecycle Information:

[STMicroelectronics:](#)

[STPS10H100CT](#) [STPS10H100CG](#) [STPS10H100CFP](#) [STPS10H100CG-TR](#)