

Ordering number: EN2202B

Thick Film Hybrid IC

**STK4152II**

AF Power Amplifier (Split Power Supply) (30W + 30W min, THD = 0.4%)

Features

- The STK4102II series (STK4152II) and STK4101V series (high-grade type) are pin-compatible in the output range of 6W to 50W and enable easy design.
- Small-sized package whose pin assignment is the same as that of the STK4101II series
- Built-in muting circuit to cut off various kinds of pop noise
- Greatly reduced heat sink due to substrate temperature 125°C guaranteed
- Excellent cost performance

Package Dimensions

unit: mm

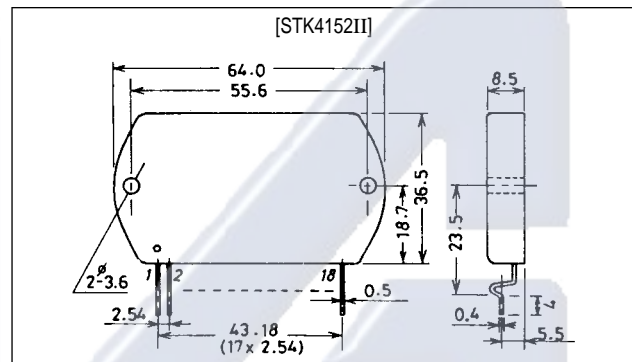
4040

Specifications

Maximum Ratings at $T_a = 25^\circ\text{C}$

Parameter	Symbol	Conditions	Ratings	Unit
Maximum supply voltage	$V_{CC \text{ max}}$		± 42	V
Thermal resistance	θ_{j-c}		2.1	$^\circ\text{C}/\text{W}$
Junction Temperature	T_j		150	$^\circ\text{C}$
Operating substrate temperature	T_c		125	$^\circ\text{C}$
Storage temperature	T_{stg}		-30 to +125	$^\circ\text{C}$
Available time for load short-circuit	t_s	$V_{CC} = \pm 27.5\text{V}$, $R_L = 8\Omega$, $f = 50\text{Hz}$, $P_o = 30\text{W}$	2	s

Recommended Operating Conditions at $T_a = 25^\circ\text{C}$

Parameter	Symbol	Conditions	Ratings	Unit
Recommended supply voltage	V_{CC}		± 27.5	V
Load resistance	R_L		8	Ω

SANYO Electric Co., Ltd. Semiconductor Business Headquarters

TOKYO OFFICE Tokyo Bldg., 1-10, 1 Chome, Ueno, Taito-ku, TOKYO, 110 JAPAN

70997HA (ID) / 92293YK / O138YT / 9068MO, TS No. 2202—1/8

STK4152II

Operating Characteristics at $T_a = 25^\circ\text{C}$, $V_{CC} = \pm 27.5\text{V}$, $R_L = 8\Omega$, $R_g = 600\Omega$, $V_G = 40\text{dB}$,
 R_L : non-inductive load

Parameter	Symbol	Conditions	min	typ	max	Unit
Quiescent current	I_{CCQ}	$V_{CC} = \pm 33\text{V}$	20	40	100	mA
Output power	P_o (1)	THD = 0.4%, $f = 20\text{Hz}$ to 20kHz	30			W
	P_o (2)	$V_{CC} = \pm 25\text{V}$, THD = 1.0%, $R_L = 4\Omega$, $f = 1\text{kHz}$	35			W
Total harmonic distortion	THD	$P_o = 1.0\text{W}$, $f = 1\text{kHz}$			0.3	%
Frequency response	f_L, f_H	$P_o = 1.0\text{W}$, $+0$ -3 dB		20 to 50k		Hz
Input impedance	r_i	$P_o = 1.0\text{W}$, $f = 1\text{kHz}$		55		$k\Omega$
Output noise voltage	V_{NO}	$V_{CC} = \pm 33\text{V}$, $R_g = 10k\Omega$			1.2	mVrms
Neutral voltage	V_N	$V_{CC} = \pm 33\text{V}$	-70	0	+70	mV
Muting voltage	V_M		-2	-5	-10	V

Notes. For power supply at the time of test, use a constant-voltage power supply unless otherwise specified.
 For measurement of the available time for load short-circuit and output noise voltage, use the specified transformer power supply shown right.
 The output noise voltage is represented by the peak value on rms scale (VTVM) of average value indicating type. For AC power supply, use an AC stabilized power supply (50Hz) to eliminate the effect of flicker noise in AC primary line.

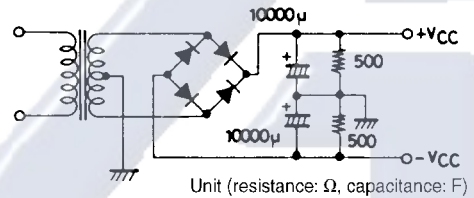

Unit (resistance: Ω , capacitance: F)

Specified Transformer Power Supply
(Equivalent to RP-25)

Equivalent Circuit

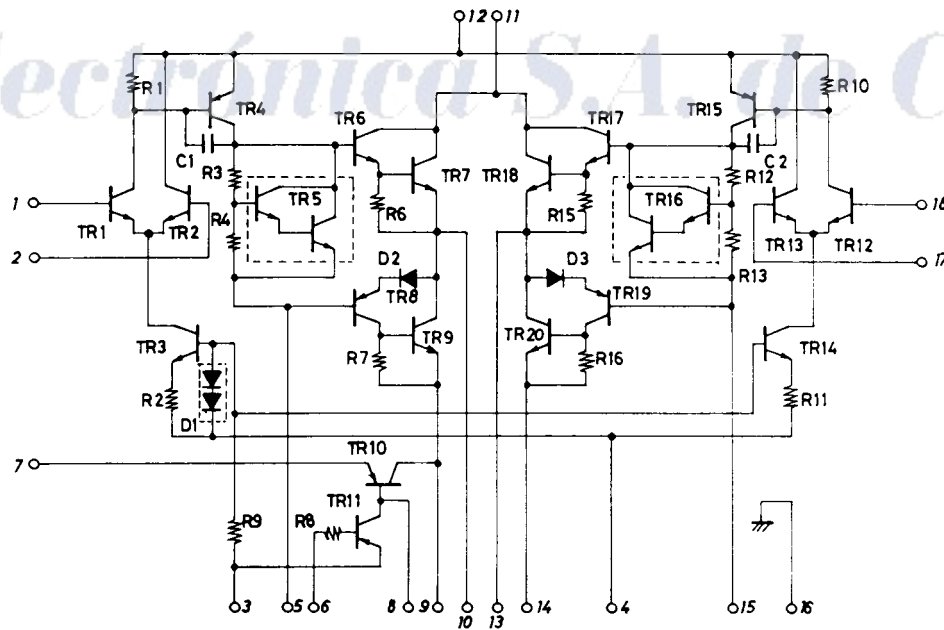

STK4152II

Sample Application Circuit : 30W min 2-channel AF power amplifier

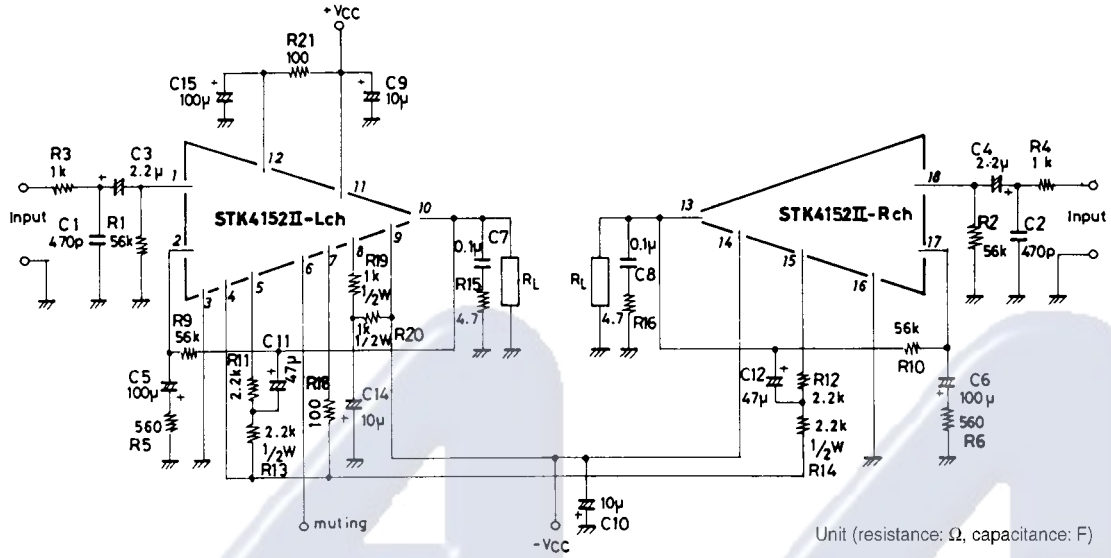

Sample Printed Circuit Pattern for Application Circuit (Cu-foiled side)

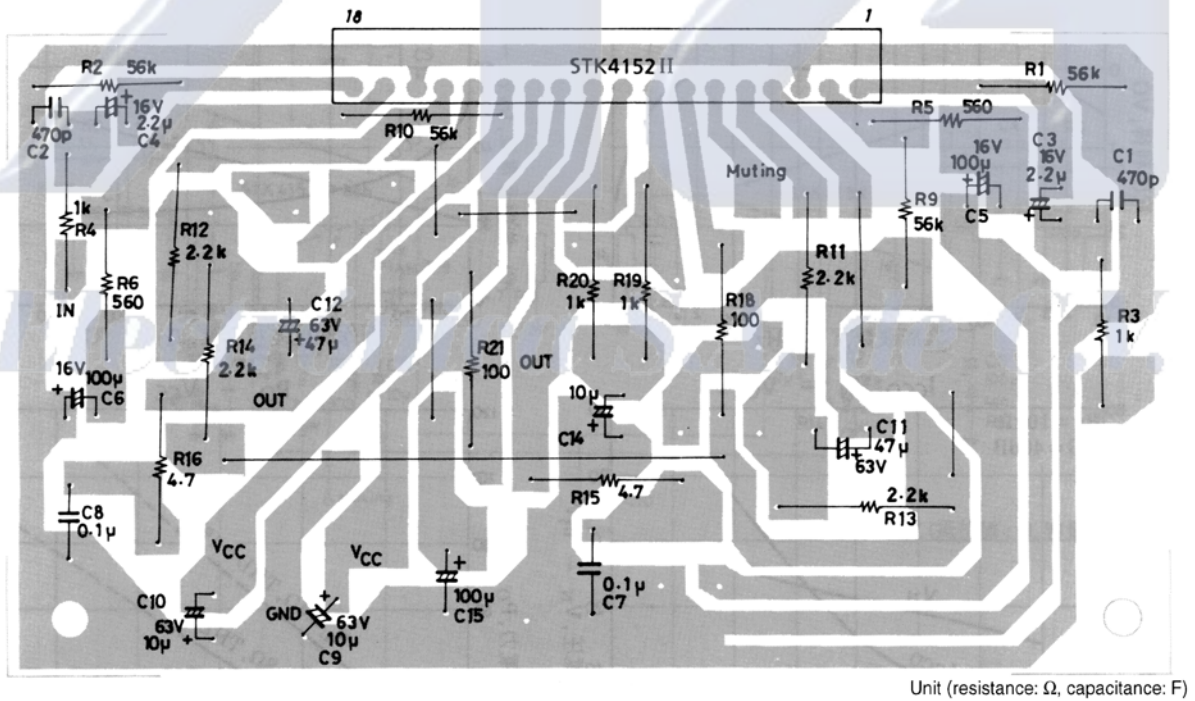

STK4152II

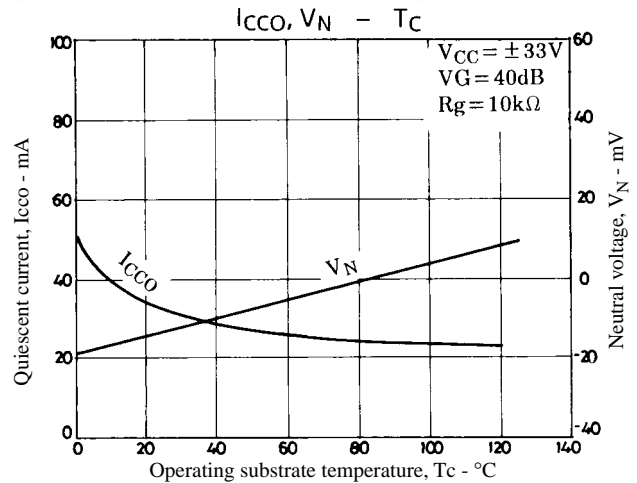
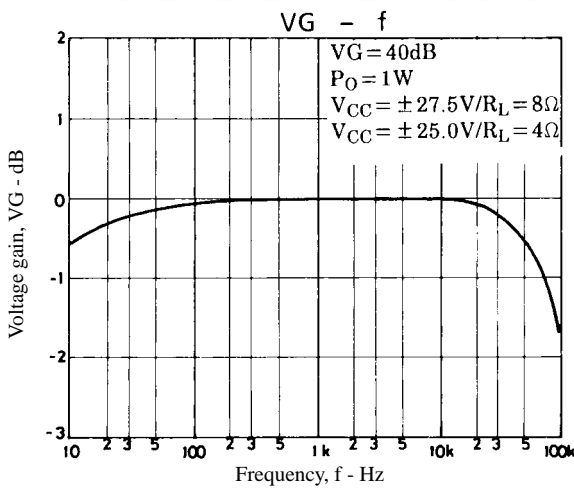
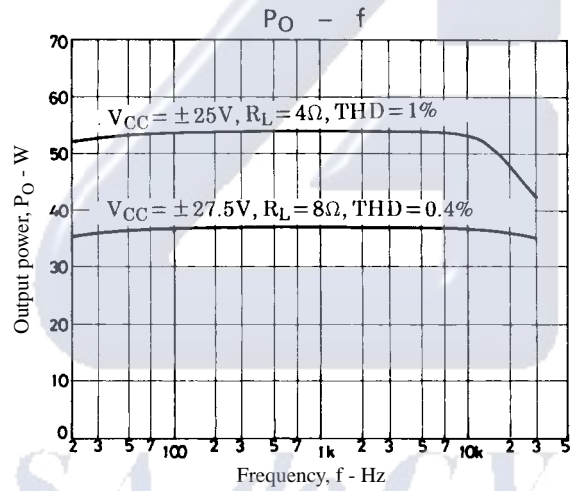
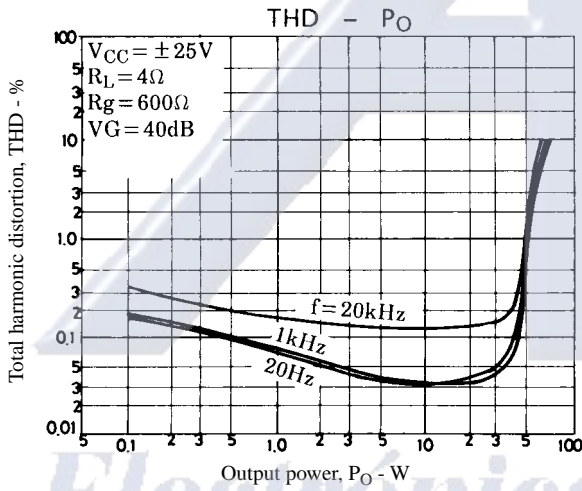
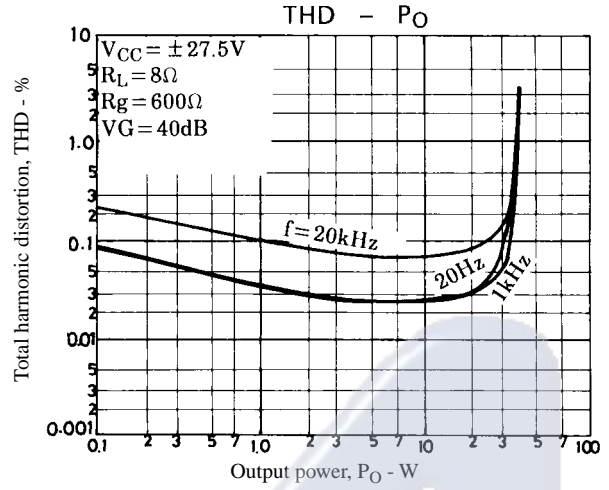
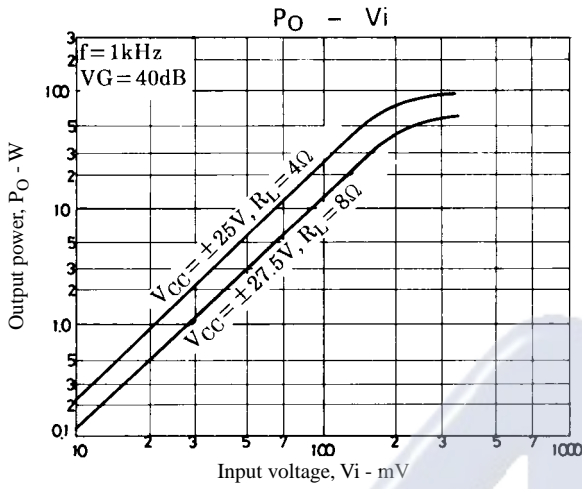

Electrónica S.A. de C.V.

STK4152II

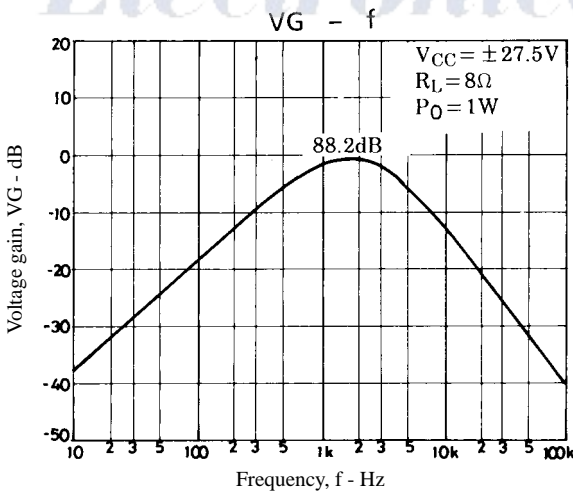
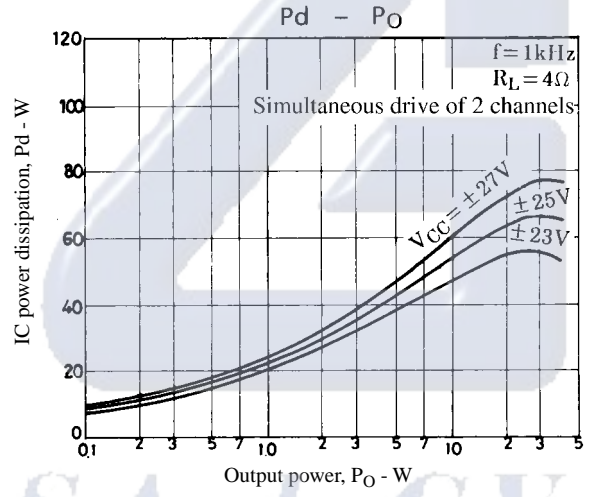
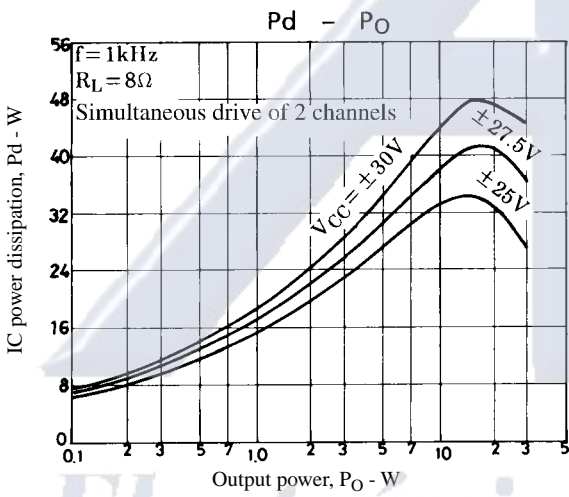
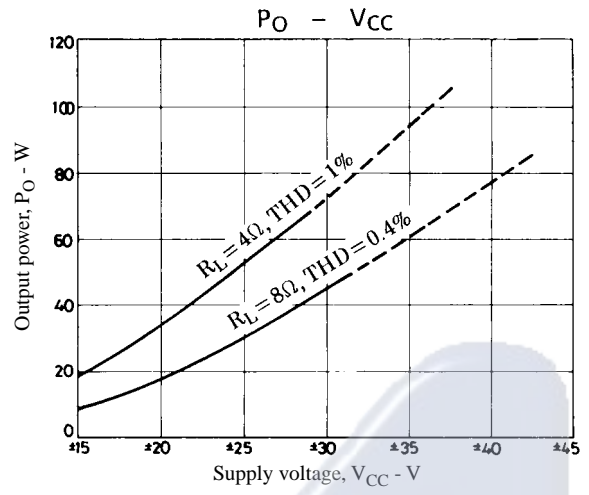
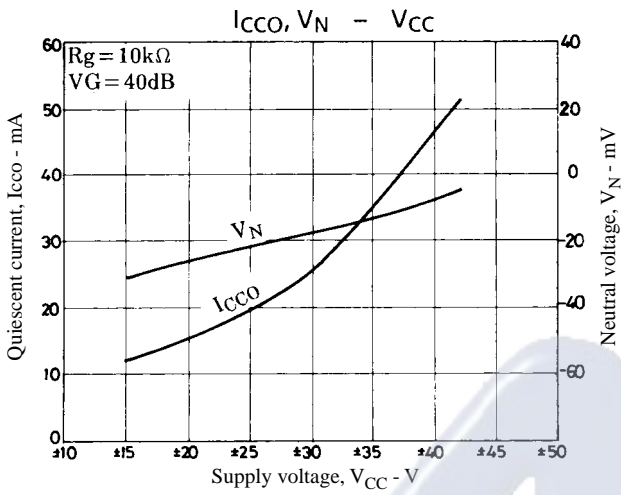

Electronica S.A. de C.V.

STK4152II

Description of External Parts

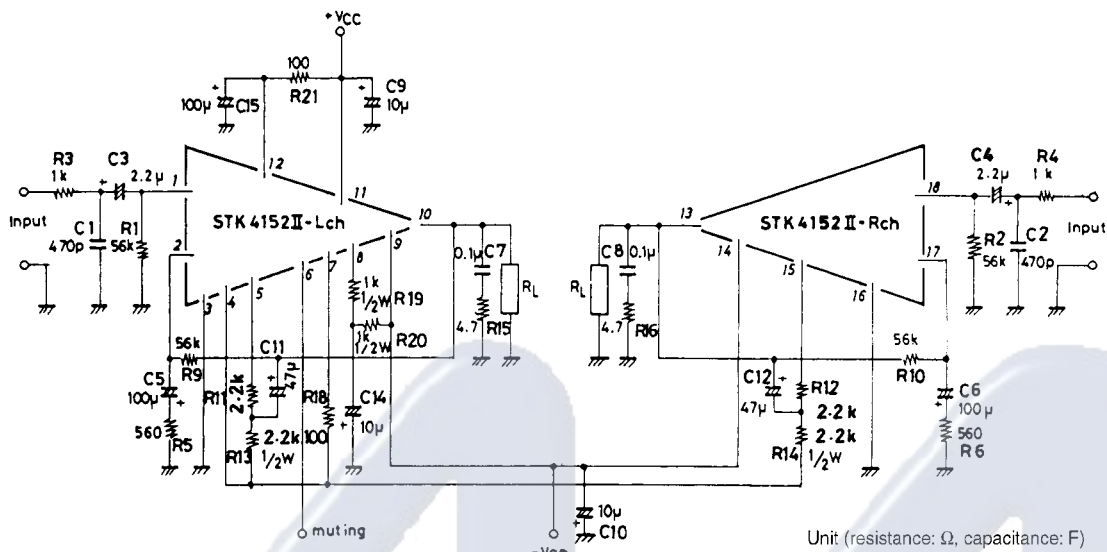

C1, C2	Input filter capacitors • A filter formed with R3 or R4 can be used to reduce noise at high frequencies.
C3, C4	Input coupling capacitors • Used to block DC current. When the reactance of the capacitor increases at low frequencies, the dependence of 1/f noise on signal source resistance causes the output noise to worsen. It is better to decrease the reactance. • To reduce the pop noise at the time of application of power, it is effective to increase C3, C4 that fix the time constant on the input side and to decrease C5, C6 on the NF side.
C5, C6	NF capacitors • These capacitors fix the low cutoff frequency as shown below. $f_L = \frac{1}{2\pi \cdot C5 \cdot R5} \text{ [Hz]}$ To provide the desired voltage gain at low frequencies, it is better to increase C5. However, do not increase C5 more than needed because the pop noise level becomes higher at the time of application of power.
C15	Decoupling capacitor • Used to eliminate the ripple components that mix into the input side from the power line (+V _{CC}).
C11, C12	Bootstrap capacitors • When the capacitor value is decreased, the distortion is liable to be higher at low frequencies.
C9, C10	Oscillation blocking capacitors • Must be inserted as close to the IC power supply pins as possible so that the power supply impedance is decreased to operate the IC stably. • Electrolytic capacitors are recommended for C9, C10.
C14	Capacitor for ripple filter • Capacitor for the TR10-used ripple filter in the IC system
C7	Oscillation blocking capacitor • A polyester film capacitor, being excellent in temperature characteristic, frequency characteristic, is recommended for C7.
R3, R4	Resistors for input filter
R1, R2	Input bias resistors • Used to bias the input pin potential to zero. These resistors fix the input impedance practically.
R5, R9 (R6, R10)	These resistors fix voltage gain V _G . It is recommended to use R5 (R6) = 560Ω, R9 (R10) = 56kΩ for V _G = 40dB. • To adjust V _G , it is desirable to change R9 (or R10). • When R9 (or R10) is changed to adjust V _G , R1 (=R2) =R9 (=R10) must be set to ensure V _N balance.
R11, R13 (R12, R14)	Bootstrap resistors • The quiescent current is set by these resistors 2.2kΩ + 2.2kΩ. It is recommended to use this resistor value.
R21	Resistor for ripple filter • (Limiting resistor for predriver transistor at the time of load short)
R18	Used to ensure plus/minus balance at the time of clip.
R19, R20	Resistor for ripple filter • When muting TR11 is turned ON, current flows from ground to -V _{CC} through TR 11. It is recommended to use 1kΩ (1/2W) + 1kΩ (1/2W) allowing for the power that may be dissipated on that occasion.
R15, R16	Oscillation blocking resistors

STK4152II

Sample Application Circuit (protection circuit and muting circuit)

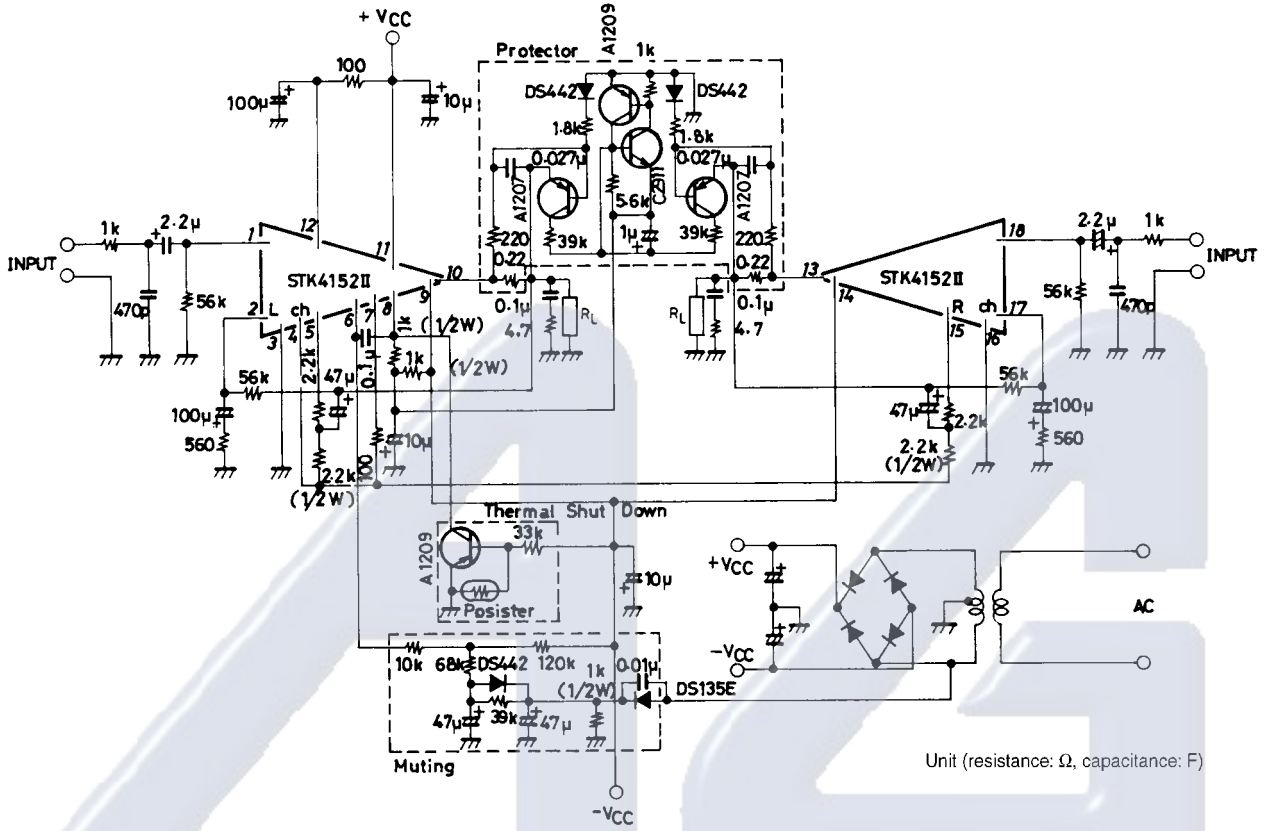

Thermal Design

The IC power dissipation of the STK4152II at the IC-operated mode is 41.4W max. at load resistance 8Ω and 67W max. at load resistance 4Ω (simultaneous drive of 2 channels) for continuous sine wave as shown in Figure 1 and 2.

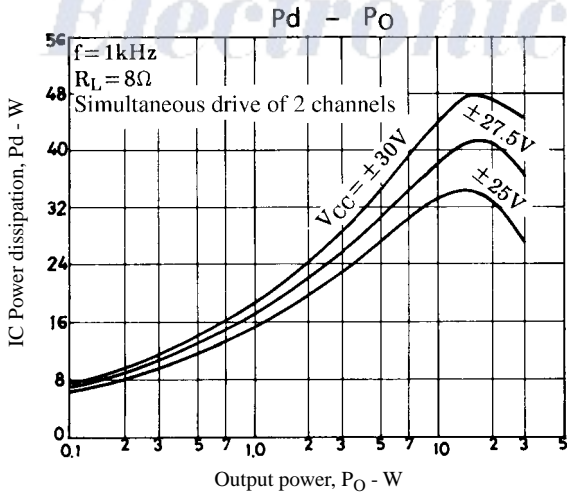

Figure 1. STK4152II Pd – P_O (R_L = 8Ω)

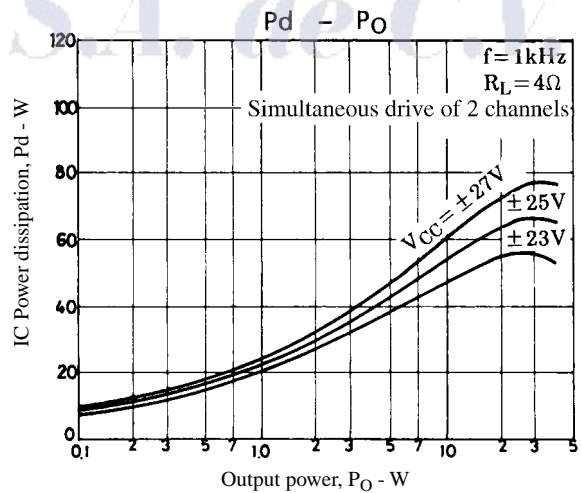

Figure 2. STK4152II Pd – P_O (R_L = 4Ω)

STK4152II

In an actual application where a music signal is used, it is impractical to estimate the power dissipation based on the continuous signal as shown above, because too large a heat sink must be used. It is reasonable to estimate the power dissipation as 1/10 Po max. (EIAJ).

That is, Pd = 26W at 8Ω, Pd = 38W at 4Ω

Thermal resistance θc-a of a heat sink for this IC power dissipation (Pd) is fixed under conditions 1 and 2 shown below.

Condition 1: $T_c = P_d \times \theta_{c-a} + T_a \leq 125^\circ\text{C}$ (1)
 where Ta : Specified ambient temperature
 Tc : Operating substrate temperature

Condition 2: $T_j = P_d \times (\theta_{c-a}) + P_d/4 \times (\theta_{j-c}) + T_a \leq 150^\circ\text{C}$ (2)
 where Tj : Junction temperature of power transistor

Assuming that the power dissipation is shared equally among the four power transistors (2 channels × 2), thermal resistance θj-c is 2.1°C/W and

$P_d \times (\theta_{c-a} + 2.1/4) + T_a \leq 150^\circ\text{C}$ (3)

Thermal resistance θc-a of a heat sink must satisfy inequalities (1) and (3).

Figure 3 shows the relation between Pd and θc-a given from (1) and (3) with Ta as a parameter.

[Example] The thermal resistance of a heat sink is obtained when the ambient temperature specified for a stereo amplifier is 50°C.

Assuming VCC = ±27.5V, RL = 8Ω,
 VCC = ±25V, RL = 4Ω,
 RL = 8Ω : Pd1 = 26W at 1/10 Po max.
 RL = 4Ω : Pd2 = 38W at 1/10 Po max.

The thermal resistance of a heat sink is obtained from Figure 3.

RL = 8Ω : θc-a1 = 2.88°C/W
 RL = 4Ω : θc-a2 = 1.97°C/W

Tj when a heat sink is used is obtained from (3).

RL = 8Ω : Tj = 138.7°C
 RL = 4Ω : Tj = 145.0°C

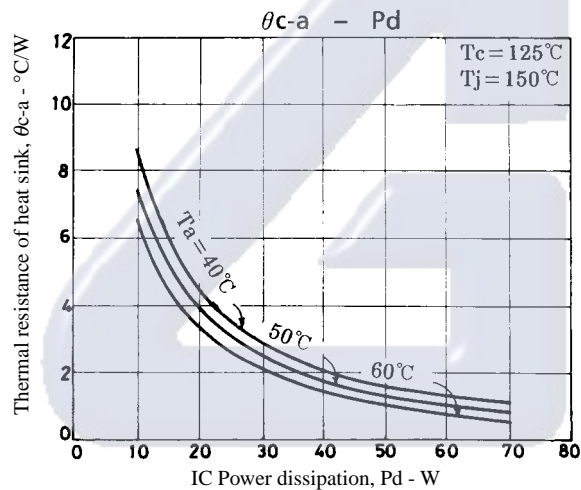

Figure 3. STK4152II θc-a – Pd

- No products described or contained herein are intended for use in surgical implants, life-support systems, aerospace equipment, nuclear power control systems, vehicles, disaster/crime-prevention equipment and the like, the failure of which may directly or indirectly cause injury, death or property loss.
- Anyone purchasing any products described or contained herein for an above-mentioned use shall:
 - ① Accept full responsibility and indemnify and defend SANYO ELECTRIC CO., LTD., its affiliates, subsidiaries and distributors and all their officers and employees, jointly and severally, against any and all claims and litigation and all damages, cost and expenses associated with such use:
 - ② Not impose any responsibility for any fault or negligence which may be cited in any such claim or litigation on SANYO ELECTRIC CO., LTD., its affiliates, subsidiaries and distributors or any of their officers and employees, jointly or severally.
- Information (including circuit diagrams and circuit parameters) herein is for example only; it is not guaranteed for volume production. SANYO believes information herein is accurate and reliable, but no guarantees are made or implied regarding its use or any infringements of intellectual property rights or other rights of third parties.

This catalog provides information as of July, 1997. Specifications and information herein are subject to change without notice.