

MOTOROLA
SEMICONDUCTOR TECHNICAL DATA

MAC210FP
Series
MAC210AFP
Series

Triacs
Silicon Bidirectional Thyristors

... designed primarily for full-wave ac control applications, such as light dimmers, motor controls, heating controls and power supplies; or wherever full-wave silicon gate controlled solid-state devices are needed. Triac type thyristors switch from a blocking to a conducting state for either polarity of applied anode voltage with positive or negative gate triggering.

- Blocking Voltage to 800 Volts
- All Diffused and Glass Passivated Junctions for Greater Parameter Uniformity and Stability
- Small, Rugged, Thermowatt Construction for Low Thermal Resistance, High Heat Dissipation and Durability
- Gate Triggering Guaranteed in Three Modes (MAC210FP Series) or Four Modes (MAC210AFP Series)

ISOLATED TRIACs
THYRISTORS
10 AMPERES RMS
200 thru 800 VOLTS

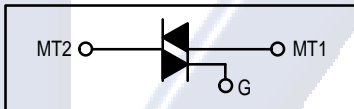
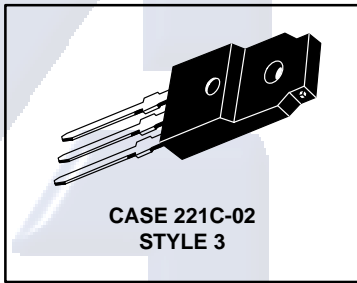

MAXIMUM RATINGS ($T_J = 25^\circ\text{C}$ unless otherwise noted.)

Rating	Symbol	Value	Unit
Repetitive Peak Off-State Voltage ⁽¹⁾ ($T_J = -40$ to $+125^\circ\text{C}$) 1/2 Sine Wave 50 to 60 Hz, Gate Open MAC210-4FP, MAC210A4FP MAC210-6FP, MAC210A6FP MAC210-8FP, MAC210A8FP MAC210-10FP, MAC210A10FP	V_{DRM}	200 400 600 800	Volts
On-State RMS Current ($T_C = +70^\circ\text{C}$) Full Cycle Sine Wave 50 to 60 Hz ⁽²⁾	$I_{\text{T(RMS)}}$	10	Amps
Peak Nonrepetitive Surge Current (One Full Cycle, 60 Hz, $T_C = +70^\circ\text{C}$) preceded and followed by rated current	I_{TSM}	100	Amps
Circuit Fusing ($t = 8.3$ ms)	I^2t	40	A^2s
Peak Gate Power ($T_C = +70^\circ\text{C}$, Pulse Width = 10 μs)	P_{GM}	20	Watts
Average Gate Power ($T_C = +70^\circ\text{C}$, $t = 8.3$ ms)	$P_{\text{G(AV)}}$	0.35	Watt
Peak Gate Current ($T_C = +70^\circ\text{C}$, Pulse Width = 10 μs)	I_{GM}	2	Amps
RMS Isolation Voltage ($T_A = 25^\circ\text{C}$, Relative Humidity $\leq 20\%$)	$V_{\text{(ISO)}}$	1500	Volts
Operating Junction Temperature	T_J	-40 to +125	$^\circ\text{C}$
Storage Temperature Range	T_{stg}	-40 to +125	$^\circ\text{C}$

THERMAL CHARACTERISTICS

Characteristic	Symbol	Max	Unit
Thermal Resistance, Junction to Case	$R_{\theta\text{JC}}$	2.2	$^\circ\text{C/W}$
Thermal Resistance, Case to Sink	$R_{\theta\text{CS}}$	2.2 (typ)	$^\circ\text{C/W}$
Thermal Resistance, Junction to Ambient	$R_{\theta\text{JA}}$	60	$^\circ\text{C/W}$

1. V_{DRM} for all types can be applied on a continuous basis. Blocking voltages shall not be tested with a constant current source such that the voltage ratings of the devices are exceeded.

2. The case temperature reference point for all T_C measurements is a point on the center lead of the package as close as possible to the plastic body.

MAC210FP Series MAC210AFP Series

ELECTRICAL CHARACTERISTICS ($T_C = 25^\circ\text{C}$ unless otherwise noted.)

Characteristic	Symbol	Min	Typ	Max	Unit
Peak Blocking Current (Either Direction) ($V_D = \text{Rated } V_{DRM}$, Gate Open) $T_J = 25^\circ\text{C}$ $T_J = +125^\circ\text{C}$	I_{DRM}	— —	— —	10 2	μA mA
Peak On-State Voltage (Either Direction) ($I_{TM} = 14 \text{ A Peak}$; Pulse Width = 1 to 2 ms, Duty Cycle $\leq 2\%$)	V_{TM}	—	1.2	1.65	Volts
Gate Trigger Current (Continuous dc) (Main Terminal Voltage = 12 Vdc, $R_L = 100 \text{ Ohms}$ Minimum Gate Pulse Width = 2 μs) MT2(+), G(+) MT2(+), G(-) MT2(-), G(-) MT2(-), G(+) "A" SUFFIX ONLY	I_{GT}	— — — —	12 12 20 35	50 50 50 75	mA
Gate Trigger Voltage (Continuous dc) (Main Terminal Voltage = 12 Vdc, $R_L = 100 \text{ Ohms}$ Minimum Gate Pulse Width = 2 μs) MT2(+), G(+) MT2(+), G(-) MT2(-), G(-) MT2(-), G(+) "A" SUFFIX ONLY (Main Terminal Voltage = Rated V_{DRM} , $R_L = 10 \text{ k}\Omega$, $T_J = +125^\circ\text{C}$) MT2(+), G(+); MT2(+), G(-); MT2(-), G(-) MT2(-), G(+) "A" SUFFIX ONLY	V_{GT}	— — — — 0.2 0.2	0.9 0.9 1.1 1.4 — —	2 2 2 2.5 — —	Volts
Holding Current (Either Direction) (Main Terminal Voltage = 12 Vdc, Gate Open, Initiating Current = 500 mA, $T_C = +25^\circ\text{C}$)	I_H	—	6	50	mA
Turn-On Time (Rated V_{DRM} , $I_{TM} = 14 \text{ A}$, $I_{GT} = 120 \text{ mA}$, Rise Time = 0.1 μs , Pulse Width = 2 μs)	t_{gt}	—	1.5	—	μs
Critical Rate of Rise of Commutation Voltage ($V_D = \text{Rated } V_{DRM}$, $I_{TM} = 14 \text{ A}$, Commutating $di/dt = 5.0 \text{ A/ms}$, Gate Unenergized, $T_C = +70^\circ\text{C}$)	$dv/dt(c)$	—	5	—	$\text{V}/\mu\text{s}$
Critical Rate of Rise of Off-State Voltage ($V_D = \text{Rated } V_{DRM}$, Exponential Voltage Rise, Gate Open, $T_C = +70^\circ\text{C}$)	dv/dt	—	100	—	$\text{V}/\mu\text{s}$

Electrónica S.A. de C.V.

TYPICAL CHARACTERISTICS

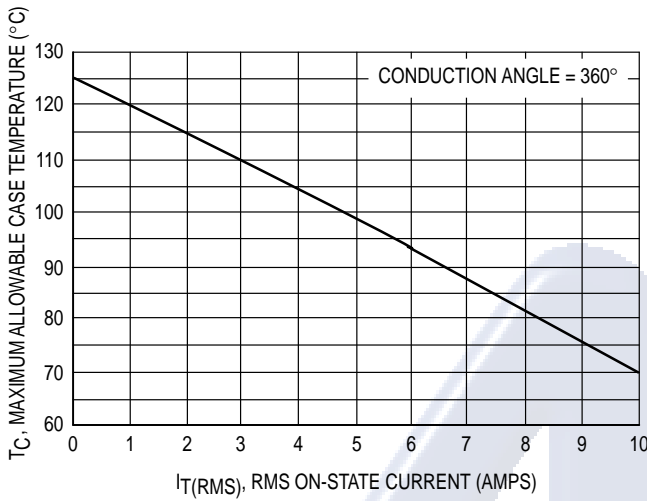

Figure 1. Current Derating

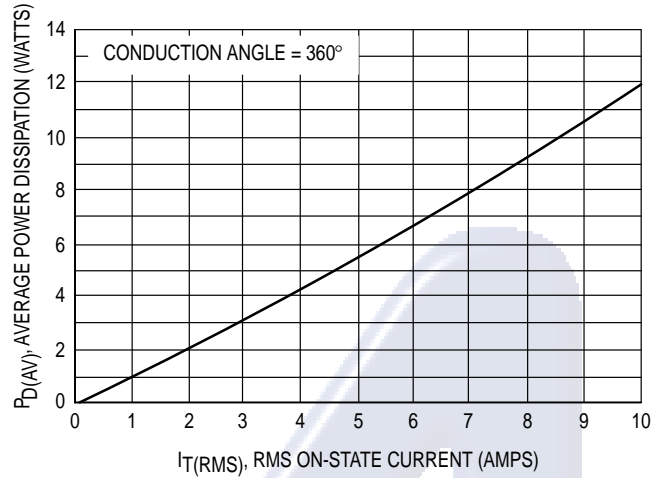

Figure 2. Power Dissipation

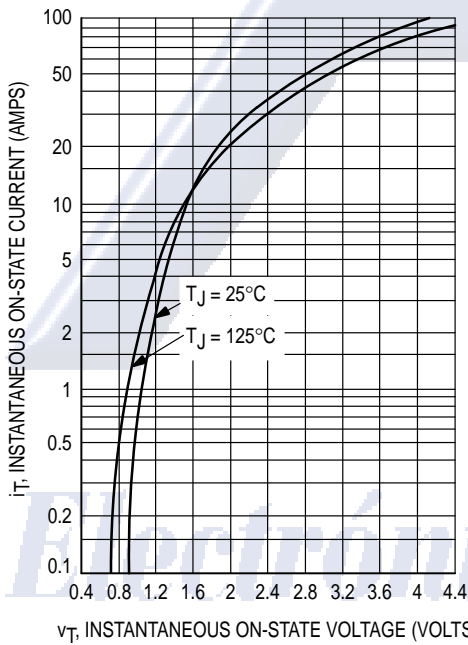

Figure 3. Maximum On-State Characteristics

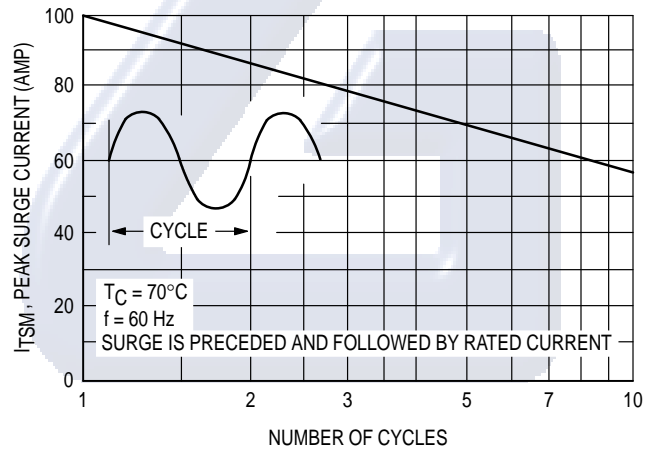

Figure 4. Maximum Nonrepetitive Surge Current

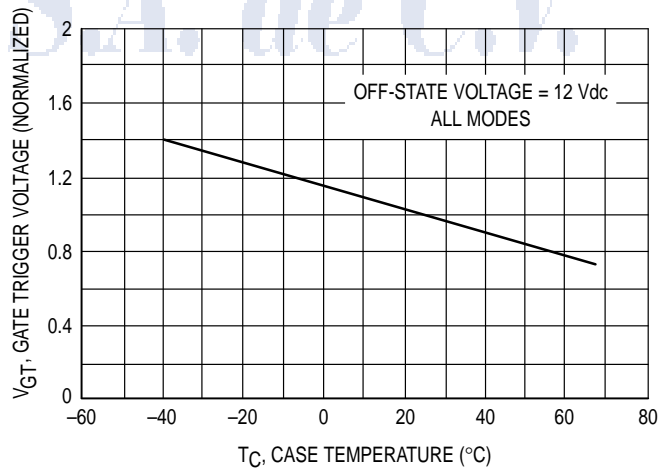

Figure 5. Typical Gate Trigger Voltage

MAC210FP Series MAC210AFP Series

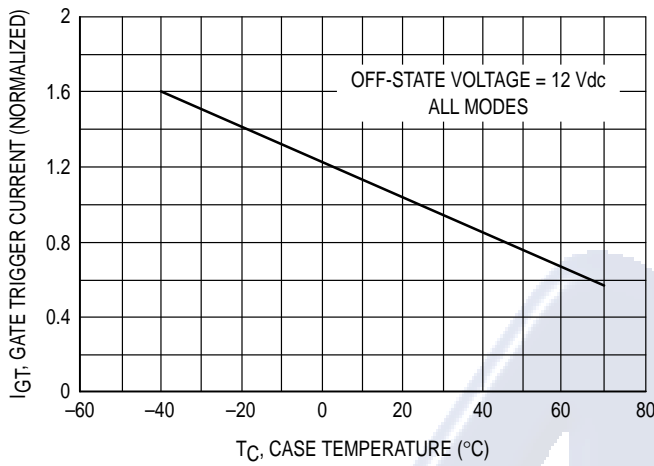

Figure 6. Typical Gate Trigger Current

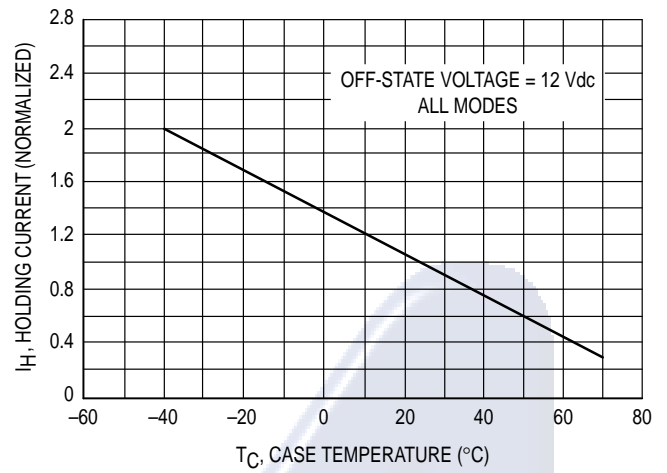

Figure 7. Typical Holding Current

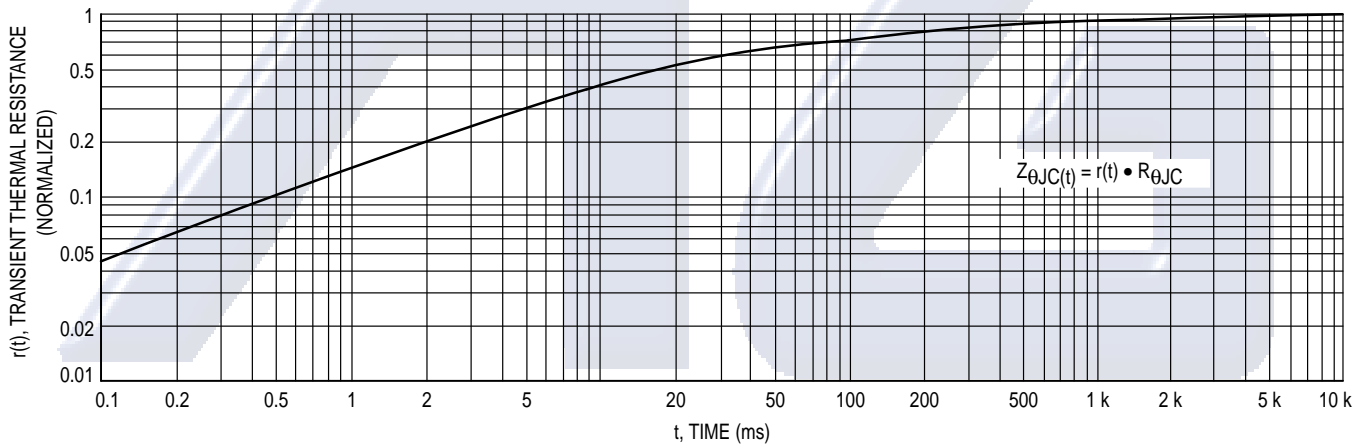
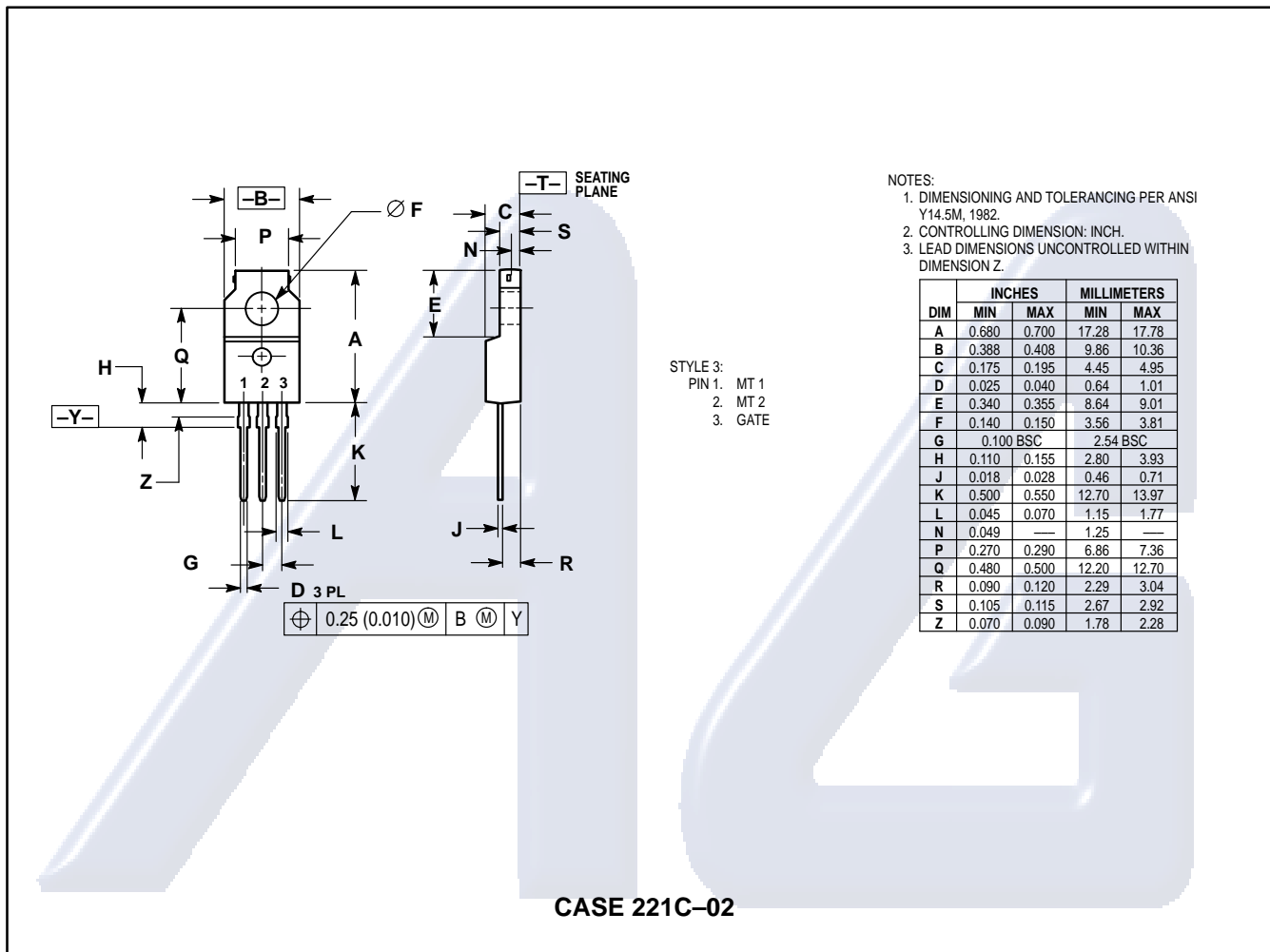

Figure 8. Thermal Response

Electrónica S.A. de C.V.

MAC210FP Series MAC210AFP Series

PACKAGE DIMENSIONS



Electrónica S.A. de C.V.

MAC210FP Series MAC210AFP Series

AG

Electrónica S.A. de C.V.

Motorola reserves the right to make changes without further notice to any products herein. Motorola makes no warranty, representation or guarantee regarding the suitability of its products for any particular purpose, nor does Motorola assume any liability arising out of the application or use of any product or circuit, and specifically disclaims any and all liability, including without limitation consequential or incidental damages. "Typical" parameters can and do vary in different applications. All operating parameters, including "Typicals" must be validated for each customer application by customer's technical experts. Motorola does not convey any license under its patent rights nor the rights of others. Motorola products are not designed, intended, or authorized for use as components in systems intended for surgical implant into the body, or other applications intended to support or sustain life, or for any other application in which the failure of the Motorola product could create a situation where personal injury or death may occur. Should Buyer purchase or use Motorola products for any such unintended or unauthorized application, Buyer shall indemnify and hold Motorola and its officers, employees, subsidiaries, affiliates, and distributors harmless against all claims, costs, damages, and expenses, and reasonable attorney fees arising out of, directly or indirectly, any claim of personal injury or death associated with such unintended or unauthorized use, even if such claim alleges that Motorola was negligent regarding the design or manufacture of the part. Motorola and [®] are registered trademarks of Motorola, Inc. Motorola, Inc. is an Equal Opportunity/Affirmative Action Employer.

Literature Distribution Centers:

USA: Motorola Literature Distribution; P.O. Box 20912; Phoenix, Arizona 85036.

EUROPE: Motorola Ltd.; European Literature Centre; 88 Tanners Drive, Blakelands, Milton Keynes, MK14 5BP, England.

JAPAN: Nippon Motorola Ltd.; 4-32-1, Nishi-Gotanda, Shinagawa-ku, Tokyo 141, Japan.

ASIA PACIFIC: Motorola Semiconductors H.K. Ltd.; Silicon Harbour Center, No. 2 Dai King Street, Tai Po Industrial Estate, Tai Po, N.T., Hong Kong.

